

W
D
D
J
G
S
R
W
S
D

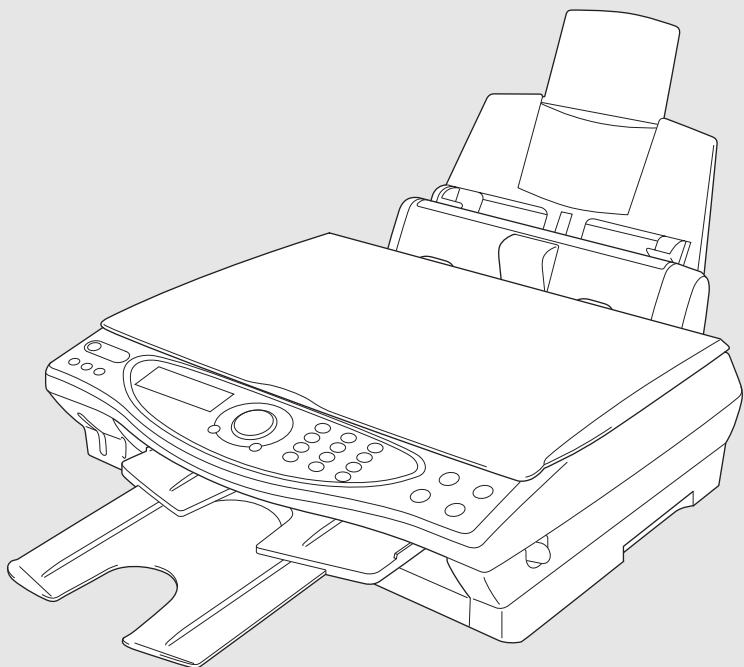

MFC-4420C

brother.

version A

If you need to call Customer Service

Please complete the following information for future reference:

Model Number: MFC-4420C

Serial Number:* _____

Date of Purchase: _____

Place of Purchase: _____

* The serial number is on the back of the unit. Retain this User's Guide with your sales receipt as a permanent record of your purchase, in the event of theft, fire or warranty service.

Register your warranty on-line at

www.registermybrother.com

By registering your product with Brother International Corporation, you will be recorded as the original owner of the product. Your registration with Brother:

- may serve as confirmation of the purchase date of your product should you lose your receipt;
- may support an insurance claim by you in the event of product loss covered by insurance; and,
- will help us notify you of enhancements to your product and special offers.

The most convenient and efficient way to register your new product is on-line at www.registermybrother.com

Brother numbers

IMPORTANT

For technical help, you must call the country where you bought the MFC. Calls must be made **from within** that country.

Register Your Product

By registering your product with Brother International Corporation, you will be recorded as the original owner of the product. Your registration with Brother:

- may serve as confirmation of the purchase date of your product should you lose your receipt;
- may support an insurance claim by you in the event of product loss covered by insurance; and,
- will help us notify you of enhancements to your product and special offers.

Please complete and fax the Brother Warranty Registration And Test Sheet or, for your convenience and most efficient way to register your new product, register on-line at

www.registermybrother.com

Frequently Asked Questions (FAQs)

The Brother Solutions Center is our one-stop resource for all your Fax Machine/Multi-Function Center needs. You can download the latest software and utilities, read FAQs and troubleshooting tips, and go to the “Solutions” section to learn how to get the most from your Brother product.

<http://solutions.brother.com>



You can check here for Brother driver updates.

For Customer Service

In USA: 1-800-284-4329 (voice)
1-901-379-1215 (fax)
1-800-284-3238 (TTY service for the hearing-impaired)

In Canada: 1-877-BROTHER (voice)
(514) 685-4898 (fax)
(514) 685-6464 (voice) **In Montreal**

Service Center Locator (USA only)

For the location of a Brother authorized service center, call 1-800-284-4357.

Service Center Locations (Canada only)

For the location of a Brother authorized service center, call 1-877-BROTHER.

Brother fax back system (USA only)

Brother has installed an easy-to-use fax back system, so you can get instant answers to common technical questions and product information for all Brother products. This system is available 24 hours a day, 7 days a week. You can use and an Index of fax back subjects.

In USA only: 1-800-521-2846

The Brother fax back system number has been preprogrammed on Speed Dial #01.

Ordering accessories and supplies

For best quality results use only genuine Brother accessories, which are available at most Brother retailers. If you cannot find the accessory you need and you have a Visa, MasterCard, Discover, or American Express credit card, you can order accessories directly from Brother. (In the USA, you can visit us online for a complete selection of the Brother accessories and supplies that are available for purchase.)

In USA: 1-888-879-3232 (voice)
1-800-947-1445 (fax)

<http://www.brothermall.com>

In Canada: 1-877-BROTHER (voice)

Description	Item
Ink Cartridge <black>	LC25BK
Ink Cartridge <cyan>(blue)	LC25C
Ink Cartridge <magenta>(red)	LC25M
Ink Cartridge <yellow>	LC25Y
Power Protector	QPD120
Telephone Line Cord	LG3077001
Paper Support	LE6522001
Output Paper Support	LE6398001
User's Guide	LE9205001 (English for USA and Canada) LE9296001 (French For Canada)
Quick Setup Guide	LE9207001 (English for USA and Canada) LE9297001 (French For Canada)
MFL Pro software on CD-ROM	LF0497001 (For CD-ROM Drive)



The Multi-Function Link® Pro Suite is NOT available on floppy disks.

Notice - Disclaimer of Warranties (USA and Canada)

BROTHER'S LICENSOR(S), AND THEIR DIRECTORS, OFFICERS, EMPLOYEES OR AGENTS (COLLECTIVELY BROTHER'S LICENSOR) MAKE NO WARRANTIES, EXPRESS OR IMPLIED, INCLUDING WITHOUT LIMITATION THE IMPLIED WARRANTIES OF MERCHANTABILITY AND FITNESS FOR A PARTICULAR PURPOSE, REGARDING THE SOFTWARE. BROTHER'S LICENSOR(S) DOES NOT WARRANT, GUARANTEE OR MAKE ANY REPRESENTATIONS REGARDING THE USE OR THE RESULTS OF THE USE OF THE SOFTWARE IN TERMS OF ITS CORRECTNESS, ACCURACY, RELIABILITY, CURRENTNESS OR OTHERWISE. THE ENTIRE RISK AS TO THE RESULTS AND PERFORMANCE OF THE SOFTWARE IS ASSUMED BY YOU. THE EXCLUSION OF IMPLIED WARRANTIES IS NOT PERMITTED BY SOME STATES IN THE USA AND SOME PROVINCES IN CANADA. THE ABOVE EXCLUSION MAY NOT APPLY TO YOU.

IN NO EVENT WILL BROTHER'S LICENSOR(S) BE LIABLE TO YOU FOR ANY CONSEQUENTIAL, INCIDENTAL OR INDIRECT DAMAGES (INCLUDING DAMAGES FOR LOSS OF BUSINESS PROFITS, BUSINESS INTERRUPTION, LOSS OF BUSINESS INFORMATION, AND THE LIKE) ARISING OUT OF THE USE OR INABILITY TO USE THE SOFTWARE EVEN IF BROTHER'S LICENSOR HAS BEEN ADVISED OF THE POSSIBILITY OF SUCH DAMAGES. BECAUSE SOME STATES IN THE USA AND SOME PROVINCES IN CANADA DO NOT ALLOW THE EXCLUSION OR LIMITATION OF LIABILITY FOR CONSEQUENTIAL OR INCIDENTAL DAMAGES, THE ABOVE LIMITATIONS MAY NOT APPLY TO YOU. IN ANY EVENT BROTHER'S LICENSOR'S LIABILITY TO YOU FOR ACTUAL DAMAGES FROM ANY CAUSE WHATSOEVER, AND REGARDLESS OF THE FORM OF THE ACTION (WHETHER IN CONTRACT, TORT (INCLUDING NEGLIGENCE), PRODUCT LIABILITY OR OTHERWISE), WILL BE LIMITED TO \$50.

Compilation and Publication Notice

Under the supervision of Brother Industries Ltd., this manual has been compiled and published, covering the latest product descriptions and specifications.

The contents of this manual and the specifications of this product are subject to change without notice.

Brother reserves the right to make changes without notice in the specifications and materials contained herein and shall not be responsible for any damages (including consequential) caused by reliance on the materials presented, including but not limited to typographical and other errors relating to the publication.

Brother® One Year Limited Warranty and Replacement Service (USA only)

Who is covered:

- This limited warranty ("warranty") is given only to the original end-use/retail purchaser (referred to in this warranty as "Original Purchaser") of the accompanying product, consumables and accessories (collectively referred to in this warranty as "this Product").
- If you purchased a product from someone other than an authorized Brother reseller in the United States or if the product was used (including but not limited to floor models or refurbished product), prior to your purchase you are not the Original Purchaser and the product that you purchased is not covered by this warranty.

What is covered:

- This Product includes a Machine and Consumable and Accessory Items. Consumable and Accessory Items include but are not limited to print heads, toner, drums, ink cartridges, print cartridges, refill ribbons, therma PLUS paper and thermal paper.
- Except as otherwise provided herein, Brother warrants that the Machine and the accompanying Consumable and Accessory Items will be free from defects in materials and workmanship, when used under normal conditions.
- This warranty applies only to products purchased and used in the United States. For products purchased in, but used outside, the United States, this warranty covers only warranty service within the United States (and does not include shipping outside the United States).

What is the length of the Warranty Periods:

- Machines: one year from the original purchase date.
- Accompanying Consumable and Accessory Items: 90 days from the original purchase date or the rated life of consumable, whichever comes first.

What is NOT covered:

This warranty does not cover:

- (1) Physical damage to this Product;
- (2) Damage caused by improper installation, improper or abnormal use, misuse, neglect or accident (including but not limited to transporting this Product without the proper preparation and/or packaging);
- (3) Damage caused by another device or software used with this Product (including

but not limited to damage resulting from use of non Brother®-brand parts and Consumable and Accessory Items);

- (4) Consumable and Accessory Items that expired in accordance with a rated life; and,
- (5) Problems arising from other than defects in materials or workmanship.

This limited warranty is VOID if this Product has been altered or modified in any way (including but not limited to attempted warranty repair without authorization from Brother and/or alteration/removal of the serial number).

What to do if you think your Product is eligible for warranty service:

Report your issue to either our Customer Service Hotline at 1-800-284-4329 or a Brother Authorized Service Center **within the applicable warranty period.** Supply Brother or the Brother Authorized Service Center with a copy of your dated bill of sale showing that this Product was purchased within the U.S. For the name of local Brother Authorized Service Center(s), call 1-800-521-2846.

What Brother will ask you to do:

After contacting Brother or a Brother Authorized Service Center, you may be required to deliver (by hand if you prefer) or send the Product properly packaged, freight prepaid, to the Authorized Service Center together with a photocopy of your bill of sale. **You are responsible for the cost of shipping, packing product, and insurance (if you desire). You are also responsible for loss or damage to this Product in shipping.**

What Brother will do:

If the problem reported concerning your Machine and/or accompanying Consumable and Accessory Items is covered by this warranty and if you first reported the problem to Brother or an Authorized Service Center within the applicable warranty period, Brother or its Authorized Service Center will repair or replace the Machine and/or accompanying Consumable and Accessory Items at no charge to you for parts or labor. The decision as to whether to repair or replace the Machine and/or accompanying Consumable and Accessory Items is made by Brother in its sole discretion. Brother reserves the right to supply a refurbished or remanufactured replacement Machine and/or accompanying Consumable and Accessory Items and use refurbished parts

Brother® One Year Limited Warranty and Replacement Service (USA only)

provided such replacement products conform to the manufacturer's specifications for new product/parts. The repaired or replacement Machine and/or accompanying Consumable and Accessory Items will be returned to you freight prepaid or made available for you to pick up at a conveniently located Authorized Service Center.

If the Machine and/or accompanying Consumable and Accessory Items are not covered by this warranty (either stage), you will be charged for shipping the Machine and/or accompanying Consumable and Accessory Items back to you.

The foregoing are your sole (i.e., only) and exclusive remedies under this warranty.

What happens when Brother elects to replace your Machine:

When a replacement Machine is authorized by Brother, and you have delivered the Machine to an Authorized Service Center, the Authorized Service Center will provide you with a replacement Machine after receiving one from Brother. If you are dealing directly with Brother, Brother will send to you a replacement Machine with the understanding that you will, after receipt of the replacement Machine, supply the required proof of purchase information, together with the Machine that Brother agreed to replace. You are then expected to pack the Machine that Brother agreed to replace in the package from the replacement Machine and return it to Brother using the pre-paid freight bill supplied by Brother in accordance with the instructions provided by Brother. Since you will be in possession of two machines, Brother will require that you provide a valid major credit card number. Brother will issue a hold against the credit card account number that you provide until Brother receives your original Product and determines that your original Product is entitled to warranty coverage. Your credit card will be charged up to the cost of a new Product only if: (i) you do not return your original Product to Brother within five (5) business days; (ii) the problems with your original Product are not covered by the limited warranty; (iii) the proper packaging instructions are not followed and has caused damage to the product; or (iv) the warranty period on your original Product has expired or has not been sufficiently validated with a copy of the proof of purchase (bill of sale). The replacement Machine you receive (even if refurbished or remanufactured) will be

covered by the balance of the limited warranty period remaining on the original Product, plus an additional thirty (30) days. You will keep the replacement Machine that is sent to you and your original Machine shall become the property of Brother. **Retain your original Accessory Items and a copy of the return freight bill, signed by the courier.**

Limitations:

Brother is not responsible for damage to or loss of any equipment, media, programs or data related to the use of this Product. Except for that repair or replacement as described above, Brother shall not be liable for any direct, indirect, incidental or consequential damages or specific relief. Because some states do not allow the exclusion or limitation of consequential or incidental damages, the above limitation may not apply to you.

THIS WARRANTY IS GIVEN IN LIEU OF ALL OTHER WARRANTIES, WRITTEN OR ORAL, WHETHER EXPRESSED BY AFFIRMATION, PROMISE, DESCRIPTION, DRAWING, MODEL OR SAMPLE. ANY AND ALL WARRANTIES OTHER THAN THIS ONE, WHETHER EXPRESS OR IMPLIED, INCLUDING IMPLIED WARRANTIES OF MERCHANTABILITY AND FITNESS FOR A PARTICULAR PURPOSE, ARE HEREBY DISCLAIMED.

- This Limited Warranty is the only warranty that Brother is giving for this Product. It is the *final expression and the exclusive and only statement* of Brother's obligations to you. It replaces all other agreements and understandings that you may have with Brother or its representatives.
- This warranty gives you certain rights and you may also have other rights that may vary from state to state.
- This Limited Warranty (and Brother's obligation to you) may not be changed in any way unless you and Brother sign the same piece of paper in which we (1) refer to this Product and your bill of sale date, (2) describe the change to this warranty and (3) agree to make that change.

Important: We recommend that you keep all original packing materials, in the event that you ship this product.

**BROTHER MULTIFUNCTION CENTER/FACSIMILE MACHINE
LIMITED WARRANTY
(Canada only)**

Pursuant to this limited warranty of 1 year from the date of purchase for labour and parts, Brother International Corporation (Canada) Ltd. ("Brother"), or its Authorized Service Centers, will repair this MFC/Facsimile machine free of charge if defective in material or workmanship. This Limited Warranty does not include cleaning, consumables (including, without limitation, print cartridges, print head, toner and drum) or damage caused by accident, neglect, misuse or improper installation or operation, any damage caused from service, maintenance, modifications, or tampering by anyone other than a Brother Authorized Service Representative, or from the use of supplies or consumable items that are non-Brother products. Operation of the MFC/Facsimile machine in excess of the specifications or with the Serial Number or Rating Label removed shall be deemed abuse and all repairs thereafter shall be the sole liability of the end-user/purchaser. In order to obtain warranty service, the MFC/Facsimile machine must be delivered or shipped freight prepaid by the end user/purchaser to a "Brother" Authorized Service Center, together with your Proof of Purchase in the form of a Sales Receipt.

For laser products: Failure to remove the Toner Cartridge (and Toner Drum Unit on applicable models) during shipping will cause severe damage to the MFC/Facsimile and will VOID the Warranty. (Refer to your Operation Manual for proper packaging.)

For ink-jet products: Do not remove the ink cartridges during shipping. Damage to your print head resulting from packing without the ink cartridges will VOID your warranty. (Refer to your Operation Manual for proper packaging.)

BROTHER DISCLAIMS ALL OTHER WARRANTIES EXPRESSED OR IMPLIED INCLUDING, WITHOUT LIMITATION, ANY IMPLIED WARRANTIES OF MERCHANTABILITY OR FITNESS FOR A PARTICULAR PURPOSE, EXCEPT TO THE EXTENT THAT ANY WARRANTIES IMPLIED BY LAW CANNOT BE VALIDLY WAIVED.

No oral or written information, advice or representation provided by Brother, its Authorized Service Centers, Distributors, Dealers, Agents or employees, shall create another warranty or modify this warranty. This warranty states Brother's entire liability and your exclusive remedy against Brother for any failure of the MFC/Facsimile machine to operate properly.

Neither Brother nor anyone else involved in the development, production, or delivery of this MFC/Facsimile machine shall be liable for any indirect, incidental, special, consequential, exemplary, or punitive damages, including lost profits, arising from the use of or inability to use the product, even if advised by the end user/purchaser of the possibility of such damages. Since some Provinces do not allow the above limitation of liability, such limitation may not apply to you.

This Limited Warranty gives you specific legal rights and you may also have other rights which vary from Province to Province.

Warranty Service is available at Brother Authorized Service Centers throughout Canada. For Technical Support or for the name and location of your nearest Authorized Service Center call 1-877-BROTHER. Within Montreal, please call (514) 685-6464.

Internet support: support@brother.ca or browse

Brother's Web Site: www.brother.com

Brother International Corporation (Canada) Ltd.
1 Rue Hôtel de Ville
Dollard-Des-Ormeaux, QC H9B 3H6







At your side.
brother®

Safety Precautions

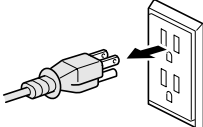
To Use the MFC Safely

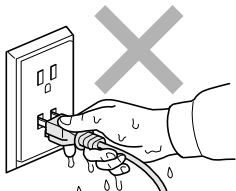
Save these instructions for later reference.

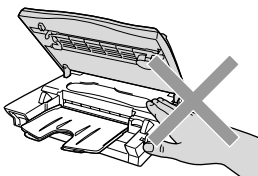
WARNING

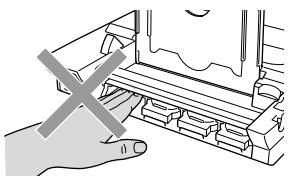
	<p>There are high voltage electrodes inside the MFC. Before you clean the MFC or clear a paper jam, make sure you have unplugged the power cord from the power outlet.</p> 		<p>Do not handle the plug with wet hands. Doing this might cause an electrical shock.</p> 
	<p>To prevent injuries, be careful not to put your hands on the edge of the MFC under the scanner cover.</p> 		<p>To prevent injuries, be careful not to put your fingers in the area shown in the illustration.</p> 

WARNING

- Use caution when installing or modifying telephone lines. Never touch telephone wires or terminals that are not insulated unless the telephone line has been disconnected at the wall jack. Never install telephone wiring during a lightning storm. Never install a telephone jack in a wet location.
- Install equipment with a power cord near a socket-outlet that is easily accessible.
- To reduce the risk of shock or fire, use only a No. 26 AWG or larger telecommunication line cord.
- Do not use a telephone in the vicinity of gas leak to report leak.

Caution

- Lightning and power surges can damage this product! We recommend that you use a quality surge protection device on the AC power line and on the telephone line, or unplug the lines during a lightning storm.
- Do not use this product near appliances that use water, in a wet basement or near a swimming pool.
- Avoid using a telephone other than a cordless type during an electrical storm. There may be a remote risk of electric shock from lightning.

Choosing a Location

Place your MFC on a flat, stable surface that is free of vibration and shocks, such as a desk. Put the MFC near a telephone jack and a standard, grounded power outlet. Choose a location where the temperature remains between 50°F and 95°F (10°-35°C).

Caution

- Avoid placing your MFC in a high-traffic area.
- Do not place near heaters, air conditioners, water, chemicals, or refrigerators.
- Do not expose the MFC to direct sunlight, excessive heat, moisture, or dust.
- Do not connect your MFC to electrical outlets controlled by wall switches or automatic timers.
- Disruption of power can wipe out information in the MFC's memory.
- Do not connect your MFC to electrical outlets on the same circuit as large appliances or other Equipment that might disrupt the power supply.
- Avoid interference sources, such as speakers or the base units of cordless phones.

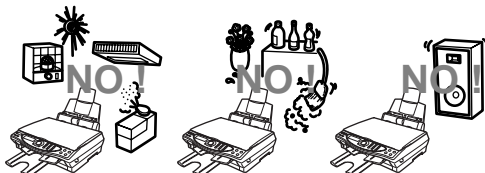

Quick Reference Guide

Sending Black & White Faxes

Automatic Transmission

Sending a fax

- 1 Place the original face down on the scanner glass.
- 2 Enter the fax number using the dial pad, Speed Dial or Search.
- 3 Press **Fax Start**.
The MFC starts scanning the first page.

NEXT PAGE?
1. YES 2. NO (DIAL)

- 4 Press **2** to begin dialing.
- 5 Press **Stop/Exit** to cancel.

Sending more than one page

- 1 Place the original face down on the scanner glass.
- 2 Enter the fax number using the dial pad, Speed Dial or Search.
- 3 Press **Fax Start**.
The MFC starts scanning the first page.

NEXT PAGE?
1. YES 2. NO (DIAL)

- 4 Press **1**.
- 5 Place the next page on the scanner glass.
Press **Menu/Set**.

The MFC starts scanning.
(Repeat step 4 and 5 for each additional page.)

- 6 Press **2** to begin dialing.
- 7 Press **Stop/Exit** to cancel.

Real Time Transmission

You can send faxes in real time.

- 1 Place the original face down on the scanner glass.
- 2 Press **Menu/Set, 2, 2, 5**.
- 3 Press  to select **ON**, and then press **Menu/Set**.

—OR—

For the next fax only, press  to select **NEXT FAX ONLY**, and then press **Menu/Set**.

- 4 For the next fax only, press  to select **ON**, and then press **Menu/Set**.
- 5 Press **1** to select additional settings.
—OR—
Press **2** to fax.
- 6 Enter the fax number.
- 7 Press **Fax Start**.

Receiving Faxes

Select Receive Mode

- 1 Press **Menu/Set**, **2**, **1**, **1**.
- 2 Press  to select **FAX ONLY**, **FAX/TEL**, **EXTERNAL TAD** or **MANUAL**, and then press **Menu/Set**. If you select **FAX/TEL**, make sure you set Ring Delay and F/T Ring Time. (See *Setting the Ring Delay* on page 5-2 and *Setting the F/T Ring Time (FAX/TEL mode only)* on page 5-3.)
- 3 Press **Stop/Exit**.

Storing Speed Dial Numbers

- 1 Press **Menu/Set**, **2**, **3**, **1**.
- 2 Enter a two-digit Speed Dial number, and then press **Menu/Set**.
- 3 Enter a number (up to 20 digits), and then press **Menu/Set**.
- 4 Enter a name (or leave it blank), and then press **Menu/Set**.
- 5 Press **Stop/Exit**.

Dialing Operations

Speed Dialing

- 1 Place the original face down on the scanner glass.
- 2 Press **Search/Speed Dial**, press **#**, and then press the two-digit Speed Dial number.
- 3 Press **Fax Start**.

Search/Speed Dial

- 1 Place the original face down on the scanner glass.
- 2 Press **Search/Speed Dial** and use the dial pad to enter the first letter of the name you are looking for.
- 3 Press  to search the memory.
- 4 Press **Fax Start**, when the LCD shows the name you want to call.

Making Copies

Making Copies

- 1 Place the original face down on the scanner glass.
- 2 Using the dial pad, enter the number of copies you want.
- 3 Press **Black Copy** or **Color Copy**.

Brother fax back system:

In USA: 1-800-521-2846

Brother Global Web Site:

<http://www.brother.com>

Frequently Asked Questions (FAQs) and Product Support

<http://solutions.brother.com>

Brother Accessories & Supplies:

In USA: 1-888-879-3232 (voice)

1-800-947-1445 (fax)

<http://www.brothermall.com>

In Canada: 1-877-BROTHER (voice)

Table of Contents

1

Introduction	1-1
Using this Guide	1-1
Finding information	1-1
Symbols used in this Guide	1-1
Fax Test Sheet and Product Registration	
(USA only)	1-2
On-Line Registration (USA and Canada)	1-2
MFC Part Names and Functions	1-3
MFC-4420C control panel overview	1-6
Turning the MFC on and off.....	1-8
Turning the MFC off	1-8
Turning the MFC on	1-8
About fax machines	1-9
Custom features	1-9
Do you have Voice Mail on the phone line?	1-9
Why should there be problems?.....	1-9
How can you avoid possible problems?	1-9
Fax tones and handshake	1-10
ECM (Error Correction Mode).....	1-11
Connecting the MFC.....	1-11
Connecting an External Telephone	1-11
Connecting an External Telephone Answering	
Device (TAD).....	1-12
Sequence	1-12
Connections	1-14
Recording Outgoing Message (OGM) on	
an External TAD	1-14
Special Line Considerations	1-15
Roll Over Phone Lines	1-15
Two-Line Phone System	1-15
Converting Telephone Wall Outlets.....	1-16
Installing MFC, External Two-Line TAD	
and Two-Line Telephone.....	1-17
Multi-Line Connections (PBX)	1-18
If you are Installing the MFC to Work	
with a PBX	1-18
Custom Features on Your Phone Line	1-18

2

Paper	2-1
About paper	2-1
Handling and using special paper.....	2-1
Recommended paper	2-2
Paper capacity of the Paper Tray	2-2
Paper specifications for the Paper Tray	2-2
Paper capacity of the Output Paper Support	2-3
Printable area	2-4
How to load paper and envelopes	2-5
To load paper or other media	2-5
To load glossy paper	2-6
To load envelopes	2-6

3

On-Screen Programming	3-1
User-friendly programming	3-1
Menu table.....	3-1
Memory Storage	3-1
Navigation key	3-2

4

Initial setup	4-1
Getting started	4-1
Setting the Paper Type.....	4-1
Setting the Paper Size.....	4-2
Setting the Date and Time	4-2
Setting the Station ID.....	4-3
Entering text	4-4
Inserting spaces	4-4
Making corrections	4-4
Repeating letters	4-4
Special characters and symbols	4-5
Setting the Ring Volume.....	4-6
Setting the Beeper Volume.....	4-6
Setting the Speaker Volume.....	4-7
Turning on Automatic Daylight Savings Time.....	4-7
Setting the LCD Contrast.....	4-8
Setting Tone and Pulse dialing mode.....	4-8

5

Setup Receive	5-1
Basic receiving operations.....	5-1
Choosing the Receive Mode.....	5-1
To select or change your Receive Mode	5-2
Setting the Ring Delay	5-2
Setting the F/T Ring Time (FAX/TEL mode only)	5-3
Easy Receive	5-4

Printing a reduced incoming fax (Auto Reduction)	5-5
Receiving a fax at the end of a conversation.....	5-5
Advanced receiving operations	5-6
Operation from extension telephones.....	5-6
For FAX/TEL mode only	5-6
Using a cordless external handset	5-7
Changing the remote codes	5-7
Printing a fax from the memory	5-7
Polling.....	5-8
Setting up Polling Receive	5-8
Setting up Sequential Polling Receive	5-8
Telephone services	5-9
Distinctive Ring.....	5-9
What does your telephone company's 'Distinctive Ring' do?	5-9
What does Brother's 'Distinctive Ring' do?	5-9
Do you have Voice Mail?.....	5-10
Before you choose the ring pattern to register	5-10
Registering the Distinctive Ring pattern	5-11
Very important	5-11
Turning off the Distinctive Ring	5-11
Caller ID.....	5-12
Viewing Caller ID List	5-13
Printing Caller ID List.....	5-13

6

Setup Send	6-1
How to Dial	6-1
Manual Dialing.....	6-1
Speed Dialing	6-1
Search	6-1
How to Fax	6-2
Automatic Transmission	6-2
Faxing A4 size originals from the scanner glass	6-3
Out of memory message	6-3
Manual Transmission	6-3
Sending a fax at the end of a conversation	6-4
Basic sending operations	6-5
Sending faxes using multiple settings	6-5
Contrast.....	6-5
Fax resolution	6-6
Color fax transmission	6-7
Manual and automatic fax redial.....	6-7
Dual Access (Not available for color faxes).....	6-8

Real Time Transmission	6-9
Checking job status	6-10
Canceling a job while scanning, dialing and sending the original	6-10
Canceling a scheduled job.....	6-10
Advanced sending operations	6-11
Broadcasting (Not available for color faxes).....	6-11
Overseas Mode	6-13
Delayed Fax (Not available for color faxes).....	6-14
Delayed Batch Transmission (Not available for color faxes).....	6-15
Setting up Polled Transmission (Not available for color faxes).....	6-16

7

Auto Dial numbers and Dialing options	7-1
Storing numbers for easy dialing	7-1
Storing Speed Dial numbers.....	7-1
Changing Speed Dial numbers.....	7-2
Setting up Groups for Broadcasting.....	7-3
Dialing options	7-4
Access codes and credit card numbers.....	7-4
Pause	7-5
Fax Redial.....	7-5
Tone or Pulse	7-5

8

Remote fax options	8-1
Setting Fax Storage	8-1
Backup Print	8-1
Fax Forwarding/Paging.....	8-2
Programming a Fax Forwarding number	8-2
Programming your pager number.....	8-3
Setting your remote access code	8-4
Remote retrieval	8-5
Using your remote access code	8-5
Remote commands.....	8-6
Retrieving fax messages	8-7
Changing your Fax Forwarding number	8-7

9

Printing reports	9-1
MFC settings and activity	9-1
Customizing the Transmission Verification Report.....	9-1
Setting the Fax Activity Report Interval	9-2
Printing reports	9-3
To print a report.....	9-3

10

Making copies	10-1
Using the MFC as a copier	10-1
Single or multiple copies.....	10-2
Out of memory message	10-3
Using Copy Options key (Temporary Settings)	10-4
No. of Copies.....	10-6
Quality	10-6
Enlarge/Reduce.....	10-7
Paper Type.....	10-8
Paper Size.....	10-9
Brightness	10-9
Page Layout	10-10
Changing the default copy settings	10-12
Copy Quality.....	10-13
Brightness.....	10-13
Contrast.....	10-13
Color Adjustment.....	10-14
Legal limitations.....	10-15

11

Walk-Up PhotoCapture Center™	11-1
Introduction	11-1
PhotoCapture Center™ requirements	11-1
Basic flow	11-2
Getting started	11-3
Printing the Index (Thumbnails).....	11-5
Printing images.....	11-6
Changing the settings for printing images	11-7
Menu selections.....	11-8
Number of Copies	11-8
Paper Type.....	11-8
Paper and Print Size	11-9
Print Quality.....	11-12
Brightness	11-12
Color enhancement (True2Life®).....	11-13
DPOF printing.....	11-14
Changing the default settings	11-15
Print Quality.....	11-16

Print Size	11-16
Brightness.....	11-16
Contrast	11-16
Color enhancement (True2Life®).....	11-17
Understanding the Error Messages	11-18
Using PhotoCapture Center™ from your PC	11-19
Using PhotoCapture Center™ for scanning originals	11-19

12

Using the MFC as a printer	12-1
Using the Brother MFC-4420C printer driver	12-1
Features.....	12-1
Choosing the right type of paper.....	12-2
How to print your document.....	12-2
Simultaneous printing and faxing.....	12-3
Clearing data from the memory	12-3
Checking the Print Quality	12-3

13

Printer driver settings	13-1
Printer driver settings.....	13-1
How to access the printer driver settings.....	13-1
Basic tab	13-2
Media Type	13-3
Quality	13-3
Bi-Directional Printing	13-4
Paper Size	13-5
Page Layout	13-5
Border Line	13-5
Orientation	13-6
Copies	13-6
Collate	13-6
Reverse Order	13-6
Near Edge Print	13-6
Advanced tab.....	13-7
Color	13-8
Color/Grayscale.....	13-8
Image Type.....	13-8
Custom Image Type	13-9
Halftone Pattern.....	13-10
Color Enhancement (True2Life®)	13-11
Scaling.....	13-13
Watermark	13-14
In background.....	13-14

In Outline Text (Window® 2000 Professional/XP Only)	13-14
Print Watermark	13-14
Watermark Style	13-15
Device Options	13-16
Print Date & Time	13-16
Quick Print Setup	13-17
Support tab	13-18
Brother Solutions Center	13-18
Web Update	13-18
Check Setting	13-18

14

How to scan using Windows®	14-1
Scanning a document (For Windows® 98/98SE/Me and 2000 Professional).....	14-1
TWAIN compliant.....	14-1
How to access the Scanner.....	14-2
Scanning a document into the PC	14-3
Scanning a whole page	14-3
PreScanning to crop a portion you want to scan ..	14-4
Settings in the Scanner window	14-6
Scan (Image Type).....	14-6
Resolution	14-6
Scan Type	14-7
Brightness	14-7
Contrast.....	14-7
Document Size	14-8
Scanning a document (For Windows® XP only)	14-10
WIA compliant	14-10
How to access the scanner	14-10
Scanning a document.....	14-11
PreScanning to crop a portion you want to scan ...	14-12
Brother Scanner Utility	14-14
Using the scan key	14-15
Scan to E-mail	14-16
Scan Image	14-16
Scan/OCR	14-17
Scan to File.....	14-17
Scan to Card.....	14-18
Changing the default color file format.....	14-19
Using ScanSoft® PaperPort® and TextBridge® OCR....	14-20
Viewing items	14-21
Organizing your items in folders	14-22
Quick links to other applications	14-22

ScanSoft® TextBridge® OCR lets you convert image text in to text you can edit	14-23
You can Import items from other applications	14-23
You can Export items in other formats.....	14-24
Exporting an image file	14-24

15

Using the Brother Control Center for Windows® 98/98SE/Me/2000 Professional	15-1
Brother MFL-Pro Control Center.....	15-1
AutoLoad the Brother Control Center	15-2
How to turn off AutoLoad.....	15-2
Brother Control Center features.....	15-3
Auto Configuration	15-3
Scan to key operations	15-4
Scan to File.....	15-5
To access Scan to File Configuration screen	15-5
Scanner Settings	15-5
Destination folder.....	15-6
Scan to E-mail	15-7
To access Scan to E-mail Configuration screen.....	15-7
Scanner Settings	15-7
E-mail application	15-8
Send to Options.....	15-8
Scan to OCR (Word Processor)	15-9
To access Scan to OCR Configuration screen	15-9
Scanner Settings	15-9
Word Processor	15-10
Scan Image.....	15-11
To access Scan to Image Configuration screen	15-11
Scanner Settings	15-11
Target Application.....	15-11

16

Using the Windows®-Based Brother SmartUI Control Center.....	16-1
Brother SmartUI Control Center	16-1
AutoLoad the Brother Control Center	16-2
How to turn off Auto Load.....	16-2
Brother Control Center features.....	16-3
Auto Configuration	16-4
Hardware Section: Changing the Scan to Button Configuration	16-5
Scan To E-mail	16-6
Scan To File.....	16-7
Scan To Image	16-8

Scan To OCR	16-10
Software Section	16-12
Scan	16-13
Copy	16-13
Fax.....	16-14
Custom	16-14
Scan to File.....	16-15
Scan to E-mail	16-17
File attachments	16-19
Scanner settings.....	16-20
Scan to OCR (Word Processing program)	16-21
Scan to Graphics application (example: Microsoft Paint).....	16-23
Copy	16-25
Fax setting (PC-Fax using the Brother Fax Driver)	16-27
FAX settings	16-28
Custom: User-defined buttons	16-30
Customizing a user-defined button.....	16-30
1. Select the Scan Action	16-30
2. Select Configuration for the Scan Type.....	16-31
3. Select Scan Settings.	16-35

17

Using MFC Remote Setup	17-1
MFC Remote Setup.....	17-1

18

Using PC-FAX	18-1
PC-FAX sending.....	18-1
Setting up user information.....	18-2
Sending setup.....	18-3
Outside line access	18-3
Include header.....	18-3
Address Book file.....	18-3
User interface	18-4
Simple style	18-4
Facsimile style.....	18-4
Speed Dial setup	18-5
The Address Book	18-6
Setting up a Member in the Address Book	18-7
Setting up a Group for Broadcasting	18-8
Editing Member information.....	18-9
Deleting a Member or Group	18-9
Exporting the Address Book	18-9
Importing to the Address Book	18-11
Setting up a Cover Page	18-12

You can enter information in each field	18-13
Sending a file as a PC-FAX using the Facsimile style	18-14
Redial	18-15
Sending a file as a PC-FAX using the Simple style ...	18-15

19

Using the PhotoCapture Center™ from your PC	19-1
Introduction	19-1
Using ArcSoft® PhotoPrinter® 4	19-3
Overview of basic steps.....	19-3

20

Using your MFC with a Macintosh®	20-1
Setting up your USB-equipped Apple® Macintosh® G3, G4 or iMac™ or iBook™ with Mac OS 8.6-9.2 or Mac OS X 10.1/10.2.1 or greater.....	20-1
Using the Brother printer driver with your Apple® Macintosh® (OS 8.6-9.2).....	20-2
Using the Brother Printer Driver with Your Apple® Macintosh® (OS X 10.1/10.2.1 or greater)	20-4
Choosing page setup options	20-4
Printing a document.....	20-4
Choosing printing options	20-5
Sending a fax from your Macintosh® application (OS 8.6-9.2).....	20-6
Setting up your Address Book	20-8
Adding a new Member.....	20-8
Adding a new Group.....	20-9
Using the Brother TWAIN scanner driver with your Macintosh® (For Mac OS 8.6-9.2 and OS X 10.2.1 or greater).....	20-11
Accessing the scanner.....	20-11
Scanning an image into your Macintosh®	20-12
Scanning a whole page	20-12
PreScanning an image	20-13
Settings in the Scanner window.....	20-14
Image.....	20-14
Scanning Area	20-16
Business Card Size	20-16
Adjusting the Image.....	20-17
Color Sync Dialog	20-18
Scanner Profile	20-19
MFC Remote Setup (Mac OS 10.1/10.2.1 or greater).....	20-20

Using the PhotoCapture Center™ from a Macintosh®	20-21
Using ArcSoft® PhotoPrinter® 4	20-22
Overview of basic steps.....	20-22

21

Important information	21-1
Standard telephone and FCC Notices	21-1
These notices are in effect on models sold and used in the United States only.....	21-1
Federal Communications Commission (FCC) Declaration of Conformity (USA only)	21-3
Important	21-4
Industry Canada Compliance Statement (Canada only).....	21-4
Important safety instructions.....	21-5
Trademarks	21-7

22

Troubleshooting and routine maintenance	22-1
Troubleshooting	22-1
Error Messages	22-1
Printer Jam or Paper Jam.....	22-3
If you are having difficulty with your MFC.....	22-6
How to improve print quality	22-9
Cleaning the print head	22-9
Print Quality Check.....	22-9
Checking the ink volume	22-13
Packing and shipping the MFC.....	22-14
Routine maintenance.....	22-17
Cleaning the scanner.....	22-17
Replacing the ink cartridges	22-18

G

Glossary	G-1
-----------------------	------------

S

Specifications	S-1
Product description	S-1
General.....	S-1
Print media	S-2
Copy	S-2
Photo Capture Center.....	S-2
Fax	S-3
Scanner	S-4
Printer	S-4
Interface.....	S-4
Computer Requirements	S-5
Consumable Items.....	S-5

Index	I-1
Remote Retrieval Access Card	R-1

1 Introduction

Using this Guide

Thank you for buying a Brother multi-function center (MFC). This MFC is simple to use, with LCD screen instructions to guide you through programming it. You can make the most of your MFC by taking a few minutes to read this Guide.

Finding information

All the chapter headings and subheadings are listed in the Table of Contents. You will be able to find information about a specific feature or operation by checking the Index at the back of this Guide.

Symbols used in this Guide

Throughout this Guide you'll see special symbols alerting you to important warnings, notes and actions. To make things clearer and to help you press the correct keys, we used special fonts and added some of the messages that will appear in the LCD.

Bold Bold typeface identifies specific keys on the MFC control panel.

Italics Italicized typeface emphasizes an important point or refers you to a related topic.

 Warnings inform you what to do to avoid possible personal injury or damage to the machine.

 Notes tell you how you should respond to a situation that may arise or give tips about how the current operation works with other features.

 Improper Setup alerts you to devices and operations that are not compatible with the MFC.

Fax Test Sheet and Product Registration (USA only)

After setting your Station ID, please fill in the Test Sheet included with your MFC and fax it to Brother's Automated Fax Response System as your first transmission. This will check that your MFC is working properly.

To get a response, you must have set up your Station ID.
(See *Setting the Station ID* on page 4-3.)

In USA Only: 1-877-268-9575

When your Test Sheet is received, a Confirmation Sheet and Product Registration form will be sent back to your MFC. Please fill in the form and return it to complete your registration.

On-Line Registration (USA and Canada)

- 1** Insert the MFL Pro Suite CD-ROM into your CD-ROM drive.
- 2** Click **Online Registration** to register your product.

MFC Part Names and Functions

■ Front view

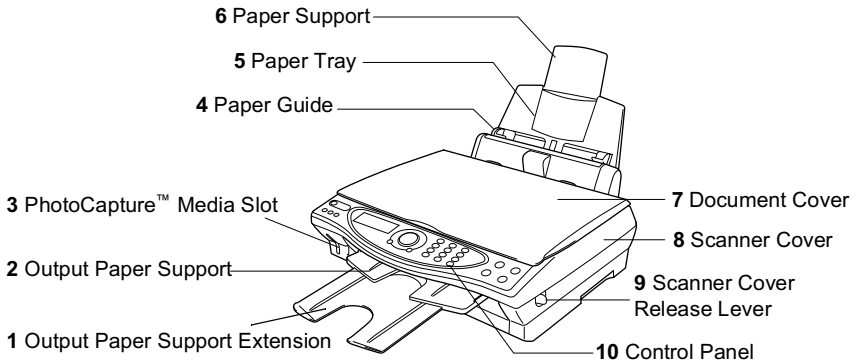

No.	Name	Description
1	Output Paper Support Extension	Pull it out to prevent the printed paper from falling.
2	Output Paper Support	Printed paper comes out here.
3	PhotoCapture™ Media Slot	Insert your Media Card into the appropriate slot to print a digital photo.
4	Paper Guide	Press and slide it to fit the paper width.
5	Paper Tray	Load paper here.
6	Paper Support	Unfold to support paper.
7	Document Cover	Open to place the original on the scanner glass.
8	Scanner Cover	Open to install an ink cartridge or to remove jammed paper.
9	Scanner Cover Release Lever	Pull to open the Scanner Cover.
10	Control Panel	Use the keys and display to control the MFC.

■ Rear View

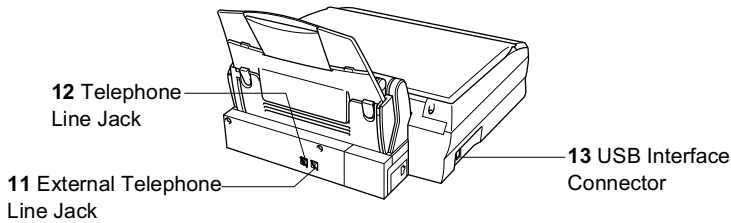

No.	Name	Description
11	External Telephone Line Jack	Plug in the modular plug on the external telephone line here.
12	Telephone Line Jack	Plug in the modular plug on the telephone line here.
13	USB Interface Connector	Connect the USB Cable here.

■ Internal View (Document Cover Open)

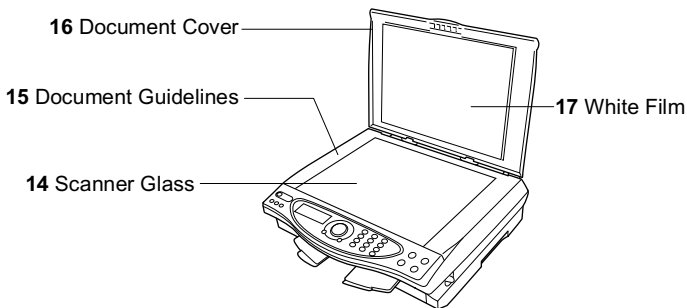

No.	Name	Description
14	Scanner Glass	Put the original to be scanned here.
15	Document Guidelines	Use to center the original on the scanner glass.
16	Document Cover	Open to place the original on the scanner glass.
17	White Film	Clean it for good quality copying and scanning.

■ Internal View (Scanner Cover Open)

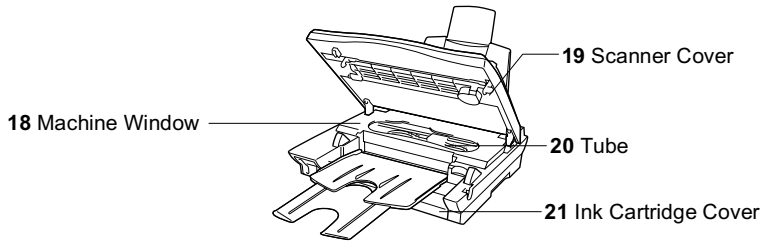

No.	Name	Description
18	Machine Window	Use to remove small paper jammed inside the MFC without pulling the tube.
19	Scanner Cover	Open to install ink cartridges or remove jammed paper.
20	Tube	These tubes transfer the ink to the print heads. Pulling the tube can cause damage to the MFC.
21	Ink Cartridge Cover	Open to install the ink cartridges.

MFC-4420C control panel overview

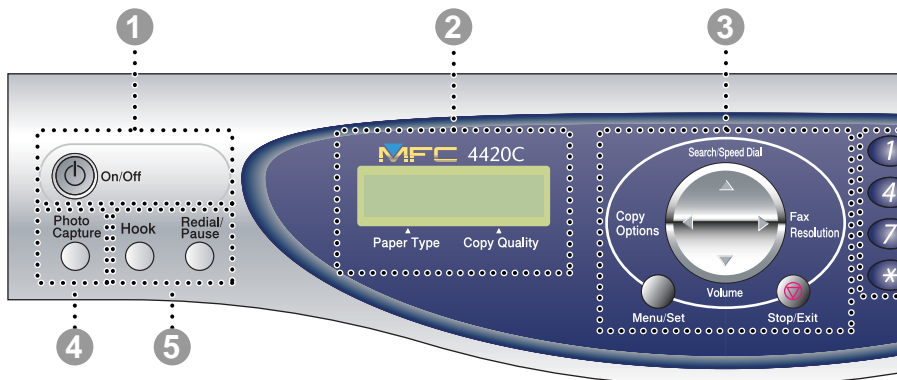

1 On/Off

You can turn the MFC on or off.

2 Liquid Crystal Display (LCD)

Displays messages on the screen to help you to set up and use your MFC.

3 Navigation Key:



Copy Options

You can quickly and easily select temporary settings for copying.



Fax Resolution

You can temporarily change the resolution when you send a fax.



Search/Speed dial

Lets you look up numbers that are stored in the dialing memory. It also lets you dial stored numbers by pressing **#** and a two-digit number.



Volume

When using the speaker or listening to the ring, you can press this key to adjust the volume.

Menu/Set

Lets you access the Menu to program and store your settings in the MFC.



Press to scroll forward or backward to a menu selection.



Press to scroll through the menus and options.

Stop/Exit

Stops a fax, cancels an operation or exits from the menu.

4 PhotoCapture

Lets you access PhotoCapture™ Center mode by inserting your media card. After inserting your digital camera's card, press this key to print the thumbnails or digital photos or to temporarily change the settings for digital direct printing.

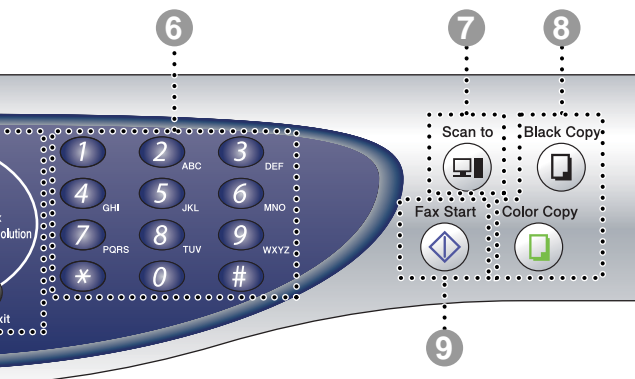

5 Telephone keys:

Hook

Press before dialing if you want to make sure a fax machine answers, and then press **Fax Start**.

Redial/Pause

Redials the last number you called. It also inserts a pause in auto dial numbers.

6 Dial Pad

Use these keys to dial telephone and fax numbers and as a keyboard for entering information into the MFC.

The # key lets you temporarily switch the dialing mode during a telephone call from Pulse to Tone.

7 Scan key:

Scan to

Lets you scan the next original and select the destination in your computer (such as a word processing, graphics or E-mail application, a Media card or a folder on your computer.)

8 Copy keys:

Black Copy

Makes a black-and-white copy.

Color Copy

Makes a full-color copy.

9 Fax Start

Starts an operation, such as sending a fax.

Turning the MFC on and off

When the MFC is idle, you can turn it on and off by pressing the **On/Off** key. In OFF mode, the MFC will send delayed faxes that have been set up and can still receive faxes in FAX ONLY, EXTERNAL TAD mode. You can even retrieve faxes using Remote Retrieval if you are away from your MFC. If you want to do other operations, you must turn the machine back on.

Turning the MFC off

Press and hold down the **On/Off** key until the LCD shows:

The LCD and scanner light will go off.

SHUTTING DOWN

Turning the MFC on

Press and hold down the **On/Off** key until the LCD shows:

The LCD will show the date and time (standby mode).

PLEASE WAIT



Even if you turned the MFC off, it will periodically clean the print head to preserve print quality.

If you unplug the AC power cord, no MFC operations will be available.

About fax machines

If you've never used an MFC before, it might seem a little mysterious. But you'll soon recognize the unusual fax tones on your phone line, and be able to send and receive faxes easily.

Custom features

Do you have Voice Mail on the phone line?

If you have Voice Mail on the phone line where you will install your new MFC, *there is a strong possibility that Voice Mail and the MFC may conflict with each other while receiving incoming calls.*

Why should there be problems?

Since both the MFC and Voice Mail will pick up the call, after the number of rings you have set, each of them has the ability to keep the other from receiving calls.

For example, if your Voice Mail is set to answer after two rings and your MFC is set to answer after four, your Voice Mail will stop your MFC from receiving faxes.

If you set Voice Mail and the Brother MFC to answer after the same number of rings, there is no way of knowing which one will answer first. It is important to remember that neither Voice Mail nor the MFC can pass the call back to the other after the call has been answered.

How can you avoid possible problems?

A very good way to avoid problems like the one mentioned, *is to get a second phone number on your present phone line.*

Many people with Voice Mail choose this service, which is called "Distinctive Ring", and they are very satisfied with it. (*See Distinctive Ring on page 5-9.*)

Another way to avoid possible problems is to replace your Voice Mail with an answering machine. Your Brother MFC is designed to work with an answering machine or TAD (telephone answering device). (*See Connecting an External Telephone Answering Device (TAD) on page 1-12.*)

Fax tones and handshake

When someone is sending a fax, the MFC sends fax calling tones (CNG tones). These are quiet, intermittent beeps every 4-seconds. You'll hear them after you dial and press **Fax Start** and they will continue for about 60 seconds after dialing. During that time, the sending machine must begin the "handshake" with the receiving machine.

Each time you use automatic procedures to send a fax, you are sending CNG tones over the phone line. You'll soon learn to listen for these quiet beeps each time you answer a phone on your fax line, so you will know if you are receiving a fax message.

The receiving fax responds with fax receiving tones, which are loud, chirping sounds. A receiving fax chirps for about 40 seconds over the phone line, and the LCD shows `RECEIVING`.

If your MFC is set to the `FAX ONLY` mode, it will answer every call automatically with fax receiving tones. If the other person hangs up, your MFC will continue to send the "chirps" for about 40 seconds, and the LCD continues to show `RECEIVING`. To cancel the receiving, press **Stop/Exit**.

The fax 'handshake' is the time in which the sending machine's CNG tones and the receiving machines "chirps" overlap. This must be for at least 2 to 4 seconds, so the machines can understand how each is sending and receiving the fax. The handshake cannot begin until the call is answered, and the CNG tones only last for about 60 seconds after the number is dialed. So it is important for the receiving machine to answer the call in as few rings as possible.



When you have an external Telephone Answering Device (TAD) on your fax line, your TAD will decide the number of rings before the call is answered.

Pay special attention to the directions for connecting a TAD in this chapter. (See *Connecting an External Telephone Answering Device (TAD)* on page 1-12.)

ECM (Error Correction Mode)

The Error Correction Mode (ECM) is a way for the MFC to check a fax transmission while it is in progress. ECM transmissions are only possible between machines that both have this feature. If they do, you may send and receive fax messages that are continuously being checked by the machine.

Your MFC must have enough memory for this feature to work.

Connecting the MFC

Connecting an External Telephone

Although your MFC does not have a handset, you can connect a separate telephone (or telephone answering device) directly to your MFC.

Connect the modular plug on the telephone's line cord to the jack labeled EXT. on the back side of the MFC.

Whenever this phone (or TAD) is in use, the LCD shows TELEPHONE.

Connecting an External Telephone Answering Device (TAD)

Sequence

You may choose to connect an answering device. However, when you have an **external** TAD on the same telephone line as the MFC, the TAD answers all calls and the MFC “listens” for fax calling (CNG) tones. If it hears them, the MFC takes over the call and receives the fax. If it doesn’t hear CNG tones, the MFC lets the TAD continue playing your outgoing message so your caller can leave you a voice message.

The TAD must answer within four rings (the recommended setting is two rings). The MFC cannot hear CNG tones until the TAD has answered the call, and with four rings there are only 8 to 10 seconds of CNG tones left for the fax “handshake”. Make sure you carefully follow the instructions in this manual for recording your outgoing message. We do not recommend using the toll saver feature on your external answering machine if it exceeds five rings.



If you do not receive all your faxes, you must reset the setting on your external TAD to four rings or less.



If You Subscribe to your Telephone Company’s Distinctive Ring Service:

You may connect an external TAD to a separate wall jack only if you subscribe to your telephone company’s Distinctive Ring service, have registered the distinctive ring pattern on your MFC, use that number as a fax number and set your machine’s Receive mode to **MANUAL**. The recommended setting is three or four rings on the external TAD when you have the telephone company’s Distinctive Ring Service.



If You Do Not Subscribe to Distinctive Ring Service:

You must plug your TAD into the **EXT.** jack of your MFC. If your TAD is plugged into a wall jack, both your machine and the TAD will try to control the phone line. (See illustration below.)

⊘ **Do not connect a TAD elsewhere on the same phone line**
(unless you have the Distinctive Ring service).

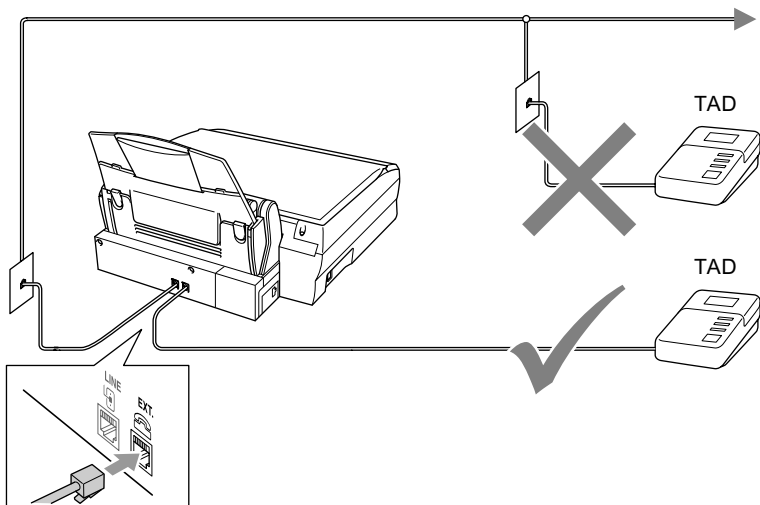

Connections

The external TAD must be plugged into the back side of the MFC, into the jack labeled EXT. Your MFC cannot work properly if you plug the TAD into a wall jack (unless you are using Distinctive Ring).

- 1** Plug the telephone line cord from the wall jack into the back side of the MFC, in the jack labeled LINE.
- 2** Plug the telephone line cord from your external TAD into the back side of the MFC, in the jack labeled EXT. (Make sure this cord is connected to the TAD at the TAD's telephone line jack, and not its telephone set jack.)
- 3** Set your external TAD to four rings or less. (The MFC's Ring Delay setting does not apply.)
- 4** Record the outgoing message on your external TAD.
- 5** Set the TAD to answer calls.
- 6** Set the Receive Mode to `EXTERNAL TAD`.
(See *Choosing the Receive Mode* on page 5-1.)

Recording Outgoing Message (OGM) on an External TAD

Timing is important in recording this message. The message sets up the ways to handle both manual and automatic fax reception.

- 1** Record 5 seconds of silence at the beginning of your message. (This allows your MFC time to listen for the fax CNG tones of automatic transmissions before they stop.)
- 2** Limit your speaking to 20 seconds.
- 3** End your 20-second message by giving your Fax Receive Code for people sending manual faxes. For example:
*"After the beep, leave a message or send a fax by pressing * 51 and Start."*



We recommend beginning your OGM with an initial 5-second silence because the MFC cannot hear fax tones over a resonant or loud voice. You may try omitting this pause, but if your MFC has trouble receiving, then you must rerecord the OGM to include it.

Special Line Considerations

Roll Over Phone Lines

A roll over phone system is a group of two or more separate telephone lines that pass incoming calls to each other if they are busy. The calls are usually passed down or “rolled over” to the next available phone line in a preset order.

Your MFC can work in a roll over system as long as it is the last number in the sequence, so the call cannot roll away. Do not put the MFC on any of the other numbers; when the other lines are busy and a second fax call is received, the fax call would be transferred to a line that does not have a fax machine. **Your MFC will work best on a dedicated line.**

Two-Line Phone System

A two-line phone system is nothing more than two separate phone numbers on the same wall outlet. The two phone numbers can be on separate jacks (RJ11) or combined into one jack (RJ14). Your MFC must be plugged into an RJ11 jack. RJ11 and RJ14 jacks may be equal in size and appearance and both may contain four wires (black, red, green, yellow). To test the type of jack, plug in a two-line phone and see if it can access both lines. If it can, you must separate the line for your MFC. (See *Easy Receive* on page 5-4.)

Converting Telephone Wall Outlets

There are three ways to convert to an RJ11 jack. The first two ways may require assistance from the telephone company. You can change the wall outlets from one RJ14 jack to two RJ11 jacks. Or, you can have an RJ11 wall outlet installed and slave or jump one of the phone numbers to it.

The third way is the easiest: Buy a triplex adapter. You can plug a triplex adapter into an RJ14 outlet. It separates the wires into two separate RJ11 jacks (Line 1, Line 2) and a third RJ14 jack (Lines 1 and 2). If your MFC is on Line 1, plug the MFC into L1 of the triplex adapter. If your MFC is on Line 2, plug it into L2 of the triple adapter.

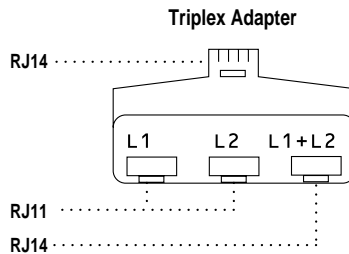

Installing MFC, External Two-Line TAD and Two-Line Telephone

When you are installing an external two-line telephone answering device (TAD) and a two-line telephone, your MFC must be isolated on one line at both the wall jack and at the TAD. The most common connection is to put the MFC on Line 2, which is explained in the following steps. The back of the two-line TAD must have two telephone jacks: one labeled L1 or L1/L2, and the other labeled L2. You will need at least three telephone line cords, the one that came with your MFC and two for your external two-line TAD. You will need a fourth line cord if you add a two-line telephone.

- 1 Place the two-line TAD and the two-line telephone next to your MFC.
- 2 Plug one end of the telephone line cord for your MFC into the L2 jack of the triplex adapter. Plug the other end into the LINE jack on the back side of the MFC.
- 3 Plug one end of the first telephone line cord for your TAD into the L1 jack of the triplex adapter. Plug the other end into the L1 or L1/L2 jack of the two-line TAD.
- 4 Plug one end of the second telephone line cord for your TAD into the L2 jack of the two-line TAD. Plug the other end into the EXT. jack on the left side of the MFC.

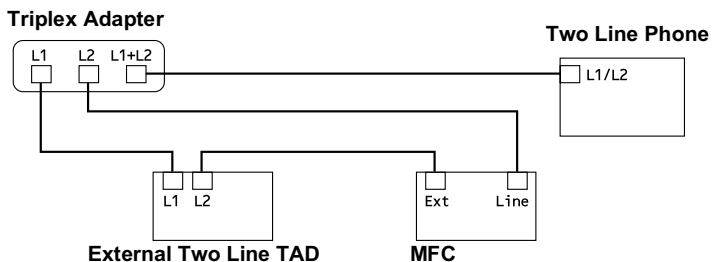

You can keep two-line telephones on other wall outlets as always. There are two ways to add a two-line telephone to the MFC's wall outlet. You can plug the telephone line cord from the two-line telephone into the L1+L2 jack of the triplex adapter. Or, you can plug the two-line telephone into the TEL jack of the two-line TAD.

Multi-Line Connections (PBX)

Most offices use a central telephone system. While it is often relatively simple to connect the machine to a key system or a PBX (Private Branch Exchange), we suggest that you contact the company that installed your telephone system and ask them to connect the MFC for you. It is advisable to have a separate line for the MFC. You can then leave the MFC in FAX mode to receive faxes any time of day or night.

If the MFC is to be connected to a multi-line system, ask your installer to connect the unit to the last line on the system. This prevents the unit from being activated each time a telephone call is received.

- ⊘ As with all fax units, this machine must be connected to a two wire system. If your line has more than two wires, proper connection of the MFC cannot be made.

If you are Installing the MFC to Work with a PBX

- 1 It is not guaranteed that the unit will operate correctly under all circumstances with a PBX. Any cases of difficulty should be reported first to the company that handles your PBX.
- 2 If all incoming calls will be answered by a switchboard operator, it is recommended that the Receive Mode be set to **MANUAL**. All incoming calls should initially be regarded as telephone calls.
- 3 The MFC may be used with either pulse or tone dialing telephone service.

Custom Features on Your Phone Line

If you have Voice Mail, Call Waiting, Call Waiting/Caller ID, RingMaster, an answering service, an alarm system or other custom feature on one phone line it may create a problem with the operation of your MFC. (See *Custom features on a single line.* on page 22-7.)

2 Paper

About paper

The print quality of your document can be affected by the kind of paper you use in the MFC.

To ensure the best print quality for the settings you've chosen, always set the Paper Type to match the type of paper you load.

You can use plain paper, inkjet paper (coated paper), glossy paper, transparencies and envelopes.

We recommend testing various paper types before purchasing large quantities.

For best results, use the recommended paper.



When you print on inkjet paper (coated paper), transparencies and glossy paper, be sure to select the proper media in the “Basic” tab in the printer driver.

Also avoid stacking by removing each page after it exits the machine to avoid smudging.

Handling and using special paper

- Store paper in its original packaging, and keep it sealed. Keep the paper flat and away from moisture, direct sunlight and heat.
- The coated side of glossy paper is shiny. Avoid touching the shiny (coated) side. Load glossy paper with the shiny side facing up toward you.
- Avoid touching either side of transparencies, because they absorb water and perspiration easily, and this may cause decreased output quality. Transparencies designed for laser printers/copiers may stain your next document. Use only recommended transparencies.

Recommended paper



The output quality depends on the paper type and paper brand. Visit us at <http://solutions.brother.com> and check the latest recommendations for paper that can be used with the MFC-4420C.

Paper capacity of the Paper Tray

Paper Type	Paper Size	Number of sheets
Plain Paper (Cut Sheet)	Letter, Executive, A4, A5	100 of 20 lb (80 g/m ²) up to 0.39 in.(10mm)
	Legal	50 of 20 lb (80 g/m ²)
Inkjet Paper	Letter	20
Glossy Paper	Letter	20
Transparencies	Letter	10
Envelopes	DL, COM-10, C5, Monarch	10
Postcard	4" x 6"	30
Index Card	5" x 8"	30

Paper specifications for the Paper Tray

Cut Sheet Paper Weight	Plain Paper / Inkjet Paper: 17 to 32 lb (64 to 120 g/m ²) Glossy Paper: Up to 40 lb (150 g/m ²) Post card: Up to 45 lb (170 g/m ²) Index card: Up to 32 lb (120 g/m ²)
Thickness	Plain Paper / Inkjet Paper: 0.003 to 0.006 in. (0.08 to 0.15 mm) Glossy Paper: Up to 0.007 in. (0.18 mm) Envelopes: Up to 0.02 in. (0.52mm) Post card: Up to 0.009 in. (0.23 mm) Index card: Up to 0.006 in. (0.15 mm)

Paper capacity of the Output Paper Support

Output Paper Support	Up to 30 sheets of 20 lb (80 g/m ²) (Transparencies and glossy paper must be picked up from the output paper support one page at a time to avoid smudging.)
----------------------	--

⊘ Do not use paper or envelopes:

- that are damaged, curled, wrinkled, or irregularly shaped

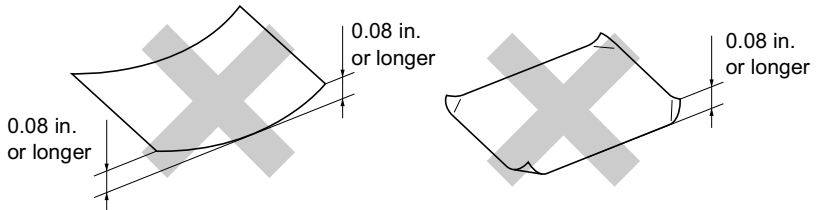

- that are extremely shiny or highly textured
- that were previously printed by a printer
- that cannot be arranged uniformly when stacked
- that are made with a short grain

⊘ Do not use envelopes:

- that are of a baggy construction
- that are embossed (have raised writing on them)
- that have clasps on them
- that are not sharply creased
- that are preprinted on the inside

Printable area

The printable area depends on the settings in the application you are using. The figures below show the unprintable areas on cut sheet paper and envelopes.

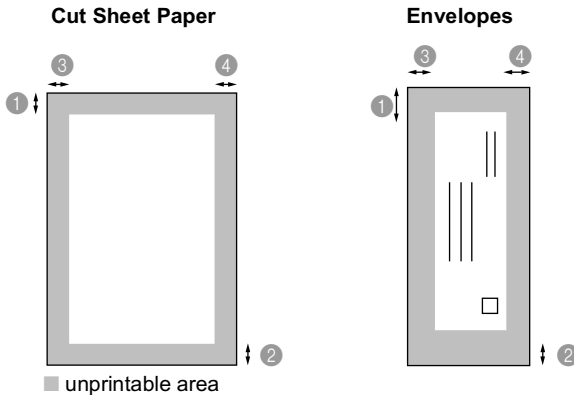

Paper	Paper Size		① Top	② Bottom	③ Left	④ Right
Cut Sheet	Letter, A4	Fax	0.12 in.	0.12 in.	0.12 in.	0.12 in.
		Printer	0.12 in. (0.02)*1	0.12 in. (0.02)*1	0.12 in. (0.02)*1	0.12 in. (0.02)*1
		Copy	0.12 in.	0.12 in.	0.12 in.	0.12 in.
	Executive, Legal	Printer	0.12 in. (0.02)*1	0.12 in. (0.02)*1	0.12 in. (0.02)*1	0.12 in. (0.02)*1
	A5	Copy	0.12 in.	0.12 in.	0.12 in.	0.12 in.
Printer		0.12 in.	0.12 in.	0.12 in.	0.12 in.	
Post Card	4" × 6"	Printer	0.12 in.	0.12 in.	0.12 in.	0.12 in.
Index Card	5" × 8"					
Envelopes	DL, C5, COM10, Monarch	Printer	0.67 in.	0.67 in.	0.12 in.	0.12 in.

*1 When you set the Near Edge feature to ON in the printer driver



Printable area depends on the Printer driver settings.

The figures above are approximate and the printable area may vary depending on the type of cut sheet paper you are using.

How to load paper and envelopes

To load paper or other media

- 1 Fan the stack of paper well to avoid paper jams and mis-feeds.

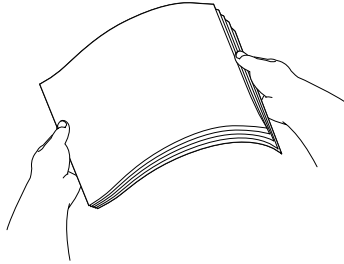

- 2 Unfold the paper support, and press and slide the paper guide to fit the paper width.

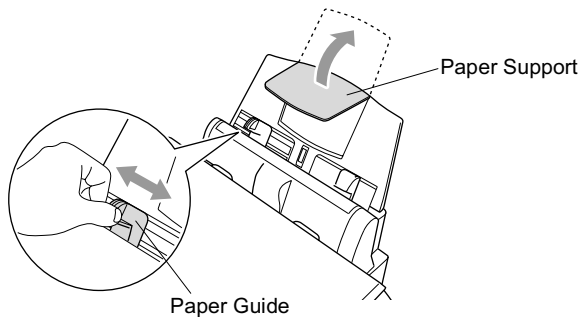

- 3 Gently insert the paper. Make sure the print side is towards you and the paper is below the maximum paper mark.

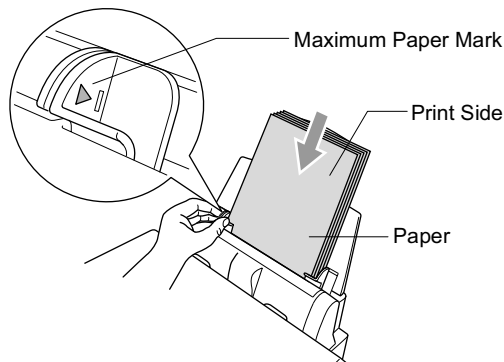

To load glossy paper

- 1 Fan the stack of glossy paper well.
- 2 Put a sheet of plain paper in the paper tray first, and then put the stack of glossy paper on top of it.



If the glossy sheets are 'double-feeding', put one sheet in the paper tray at a time.

To load envelopes

- 1 Before loading, press the corners and sides of the envelopes to make them as flat as possible.



If the envelopes are 'double-feeding', put one envelope in the paper tray at a time.

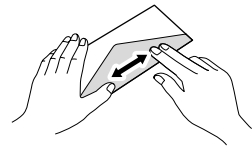
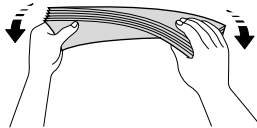
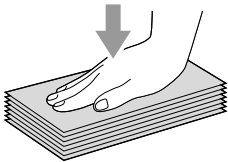

- 2 Press and slide the paper guide to fit the width of the envelopes. Insert them into the paper tray with the address side toward you and pointed in the direction below.

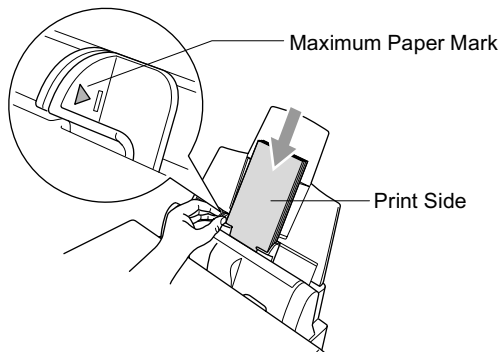

3 On-Screen Programming

User-friendly programming

Your MFC is designed to be easy to use with LCD on-screen programming using the navigation key. User-friendly programming helps you take full advantage of all the menu selections your MFC has to offer.

Since your programming is done on the LCD, we have created step-by-step on-screen instructions to help you program your MFC. All you need to do is follow the instructions as they guide you through the menu selections and programming options.

Menu table

You can probably program your machine without the User's Guide. But to help you understand the menu selections and options that are found in the MFC programs, use the Menu table on page 3-3.



You can program your MFC by pressing **Menu/Set** followed by the menu numbers.

For example to set FAX RESOLUTION to FINE:

Press **Menu/Set**, **2**, **2**, **2** and  to select FINE.

Press **Menu/Set**.

Memory Storage

If there is a power failure, you will not lose your menu settings because they are stored permanently. Temporary settings (such as Contrast, Overseas Mode, and so on) will be lost. You may also have to reset the date and time.

Navigation key

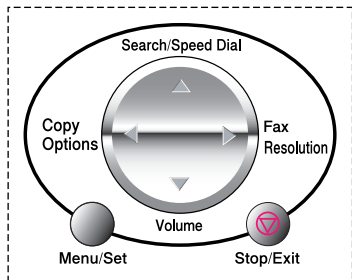

- * Access the menu
- * Go to the next menu level
- * Accept an option



- * Scroll through the current menu level



- * Go back to the previous menu level



- * Go forward to the next menu level



- * Exit the menu

You can access the menu mode by pressing **Menu/Set**.

When you enter the menu, the LCD scrolls.

Press **1** for General Setup menu

—OR—

Press **2** for Fax menu

—OR—

Press **3** for Copy menu

—OR—

Press **4** for PhotoCapture menu

—OR—

Press **5** for Maintenance menu

—OR—

Press **6** for Print Reports menu

—OR—

SELECT ↑ ↓ & SET
1. GENERAL SETUP

SELECT ↑ ↓ & SET
2. FAX

SELECT ↑ ↓ & SET
3. COPY

SELECT ↑ ↓ & SET
4. PHOTOCAPTURE

SELECT ↑ ↓ & SET
5. MAINTENANCE

SELECT ↑ ↓ & SET
6. PRINT REPORTS

You can scroll more quickly through each menu level by pressing the arrow for the direction you want on . Then set an option by pressing **Menu/Set** when that option appears on the LCD.

Then the LCD shows the next menu level.

Press  to scroll to your next menu selection.

Press **Menu/Set**.

When you finish setting an option, the LCD shows ACCEPTED.



Use  to scroll backward if you passed your choices or want to save keystrokes.

The current setting is always the option without a “?”.

Press the Menu numbers.

(ex. Press 1, 1 for

Paper Type

—OR—

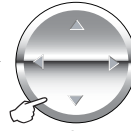

to accept



to exit

Main Menu	Submenu	Menu Selections	Options	Descriptions	Page	
1. GENERAL SETUP	1. PAPER TYPE	—	PLAIN INKJET GLOSSY (4-COLOR or 3-COLOR) TRANSPARENCY	Sets the type of paper in the paper tray.	4-1	
	2. PAPER SIZE	—	LETTER LEGAL A4	Sets the size of paper in the paper.	4-2	
	3. DATE/TIME	—	—	Puts the date and time on the LCD and in headings of faxes you send.	4-2	
	4. STATION ID	—	—	Program your name and fax number to appear on each page sent.	4-3	
	5. VOLUME	1. RING		HIGH MED LOW OFF	Adjusts the ring volume.	4-6
		2. BEEPER		HIGH MED LOW OFF	Adjusts the volume level of the beeper.	4-6
		3. SPEAKER		HIGH MED LOW OFF	Adjusts the speaker volume.	4-7



The factory settings are shown in Bold.

Press the Menu numbers.
(ex. Press 1, 1 for
Paper Type

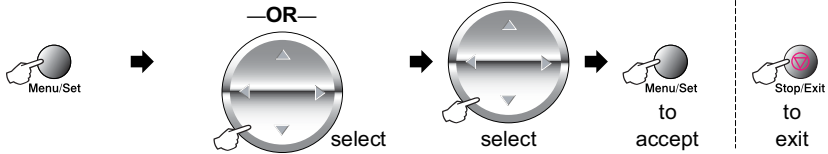

Main Menu	Submenu	Menu Selections	Options	Descriptions	Page
1. GENERAL SETUP (Continued)	6. AUTO DAYLIGHT	—	ON OFF	Changes for Daylight Savings Time automatically.	4-7
	7. LCD CONTRAST	—	- ■■■■ + - ■■■□ + - ■■■□ + - ■■■□ + - ■■■□ + - ■■■□ +	Adjusts the contrast of LCD.	4-8
	8. TONE/PULSE	—	TONE PULSE	Selects the dialing mode.	4-8
	9. LOCAL LANGUAGE (Canada Only)	—	ENGLISH FRENCH	Allows you to change the LCD Language for your country.	See French User's Guide
2. FAX	1. SETUP RECEIVE	1. RECEIVE MODE	FAX ONLY FAX/TEL EXTERNAL TAD MANUAL	You can choose the receive mode that best suits your needs.	5-2
		2. RING DELAY	04 03 02 01 00	Sets the number of rings before the MFC answers in FAX or FAX/TEL mode.	5-2
		3. F/T RING TIME	70 SEC 40 SEC 30 SEC 20 SEC	Sets the pseudo/double-ring time in FAX/TEL mode.	5-3

 The factory settings are shown in Bold.

Press the Menu numbers.

(ex. Press 1, 1 for)

Paper Type

—OR—

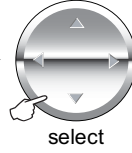
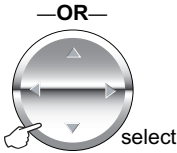

to accept



to exit

Main Menu	Submenu	Menu Selections	Options	Descriptions	Page
2.FAX (Continued)	1.SETUP RECEIVE (Continued)	4.EASY RECEIVE	ON OFF	Receives fax messages without pressing the Fax Start key.	5-4
		5.REMOTE CODE	ON (* 51, #51) OFF	You can answer all calls at an extension or external phone and use codes to turn the MFC on or off. You can personalize these codes.	5-7
		6.AUTO REDUCTION	ON OFF	Reduces the size of the incoming faxes.	5-5
		7.POLLING RX	ON OFF	Sets up your MFC to poll another fax machine.	5-8
	2.SETUP SEND	1.CONTRAST	AUTO S.LIGHT S.DARK	Changes the lightness or darkness of faxes you send.	6-5
		2.FAX RESOLUTION	STANDARD FINE S.FINE PHOTO COLOR STD COLOR FINE	Sets the default resolution for outgoing faxes.	6-6
		3.DELAYED FAX	—	Sets the time of day that the delayed faxes will be sent.	6-14
		4.BATCH TX	ON OFF	Combines delayed faxes to the same fax number at the same time of day in one transmission.	6-15
		5.REAL TIME TX	OFF ON NEXT FAX ONLY	You can send a fax without using the memory.	6-9



The factory settings are shown in Bold.

Press the Menu numbers.
(ex. Press 1, 1 for)
Paper Type

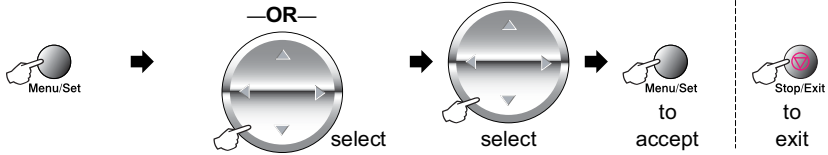

Main Menu	Submenu	Menu Selections	Options	Descriptions	Page
2.FAX (Continued)	2.SETUP SEND (Continued)	6.POLLED TX	ON OFF	Sets up your MFC with a document to be retrieved by another fax machine.	6-16
		7.OVERSEAS MODE	ON OFF	Adjusts for overseas transmissions, which can sometimes cause problems.	6-13
		0.SCAN SIZE	A4 LETTER	If originals are A4 size set Scan Glass Size to A4.	6-3
	3.SET AUTO DIAL	1.SPEED-DIAL	—	Stores Speed Dial numbers, so you can dial by pressing only a few keys.	7-1
		2.SETUP GROUPS	—	Sets up a Group number for Broadcasting.	7-3
	4.SETUP REPORTS	1.TRANSMISSION	ON ON+IMAGE OFF OFF+IMAGE	Initial setup for Transmission Verification Report and Activity Report.	9-1
		2.ACT. INTERVAL	EVERY 7 DAYS EVERY 2 DAYS EVERY 24 HOURS EVERY 12 HOURS EVERY 6 HOURS EVERY 50 FAXES OFF		9-1
	5.REMOTE FAX OPT	1.FAX FWD/PAGING	OFF FAX FORWARD PAGING	Sets the MFC to forward fax messages or to call your pager.	8-2
		2.FAX STORAGE	ON OFF	Stores incoming faxes in the memory so you can retrieve them while you are away from your machine.	8-1

 The factory settings are shown in Bold.

Press the Menu numbers.

(ex. Press 1, 1 for)

Paper Type

—OR—

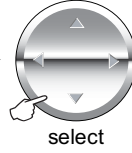
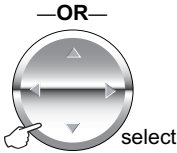

to accept



to exit

Main Menu	Submenu	Menu Selections	Options	Descriptions	Page
2.FAX (Continued)	5.REMOTE FAX OPT (Continued)	3.REMOTE ACCESS	---*	You can set your own code for remote retrieval.	8-4
		4.PRINT FAX (Backup Print)	—	Prints incoming faxes stored in the memory.	5-7
	6.REMAINING JOBS	—	—	Checks which jobs are in the memory or cancels a delayed fax or polling job.	5-8 6-10
	0.TEL SERVICE	1.DISTINCTIVE	OFF SET (ON)	Uses the Telephone Company's Distinctive Ring subscriber service to register the ring pattern with the MFC.	5-11
		2.CALLER ID (For USA Only)	—	View or print a list of the last 30 Caller IDs stored in memory.	5-13
3.COPY	1.QUALITY	—	NORMAL BEST FAST	Selects the copy quality.	10-13
	2.BRIGHTNESS	—	- ■■■■ + - ■■■□ + - ■■■□ + - ■■■□ + - ■■■□ +	Adjusts the brightness	10-13



The factory settings are shown in Bold.

Press the Menu numbers.
(ex. Press 1, 1 for)
Paper Type

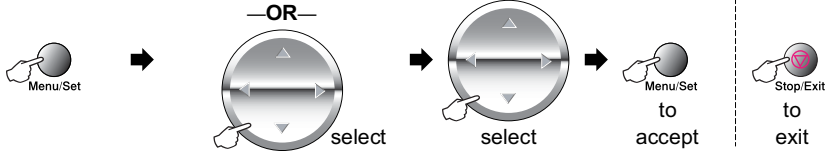

Main Menu	Submenu	Menu Selections	Options	Descriptions	Page
3.COPY (Continued)	3.CONTRAST	—	- ■■■■■ + - ■■■■□ + - ■■■□□ + - ■■□□□ + - □□□□□ +	Adjusts the contrast.	10-13
	4.COLOR ADJUST	1.RED	R:- ■■■■■ + R:- ■■■■□ + R:- ■■■□□ + R:- ■■□□□ + R:- □□□□□ +	Adjusts the amount of Red in copies.	10-14
		2.GREEN	G:- ■■■■■ + G:- ■■■■□ + G:- ■■■□□ + G:- ■■□□□ + G:- □□□□□ +	Adjusts the amount of Green in copies.	
		3.BLUE	B:- ■■■■■ + B:- ■■■■□ + B:- ■■■□□ + B:- ■■□□□ + B:- □□□□□ +	Adjusts the amount of Blue in copies.	
4.PHOTOCAPTURE	1.PRINT QUALITY	—	NORMAL FINE PHOTO	Selects the print quality.	11-16
	2.PRINT SIZE	—	5" x 3.5" 6" x 4" 7" x 5" 8" x 10"	Selects the print size	11-16
	3.BRIGHTNESS	—	- ■■■■■ + - ■■■■□ + - ■■■□□ + - ■■□□□ + - □□□□□ +	Adjusts the brightness.	11-16
	4.CONTRAST	—	- ■■■■■ + - ■■■■□ + - ■■■□□ + - ■■□□□ + - □□□□□ +	Adjusts the contrast.	11-16

 The factory settings are shown in Bold.

Press the Menu numbers.

(ex. Press 1, 1 for)

Paper Type

—OR—



to accept



to exit

Main Menu	Submenu	Menu Selections	Options	Descriptions	Page
4.PHOTOCAPTURE (Continued)	5.TRUE2LIFE	ON	1 .WHITE BALANCE - ■■■■ + - ■■■■ □ + - ■■■■ □ + - ■■■■ □ + - ■■■■ □ +	Adjusts the hue of the white areas.	11-17
		OFF	2 .SHARPNESS - ■■■■ + - ■■■■ □ + - ■■■■ □ + - ■■■■ □ + - ■■■■ □ +	Enhances the detail of the image.	
			3 .COLOR DENSITY - ■■■■ + - ■■■■ □ + - ■■■■ □ + - ■■■■ □ + - ■■■■ □ +	Adjusts the total amount of color in the image.	
	6.SCAN TO CARD	—	PDF JPEG	Selects the default file format for color scanning.	14-18
5.MAINTENANCE	1.TEST PRINT	—	—	You can print a test sample page to check the print quality and adjust the Vertical Alignment.	22-9
	2.CLEANING	—	BLACK /CYAN YELLOW/ MAGENTA ALL	You can clean the four color print heads or two colors.	22-9
	3.INK VOLUME	—	BLACK CYAN YELLOW MAGENTA	You can check the ink volume that is left in the cartridge.	22-13



The factory settings are shown in Bold.

Press the Menu numbers.
(ex. Press 1, 1 for)
Paper Type

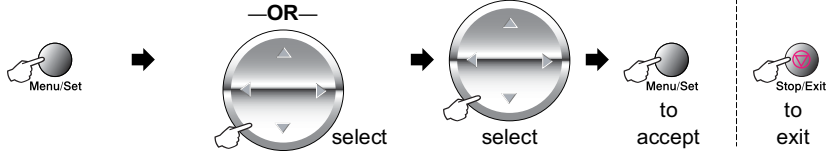

Main Menu	Submenu	Menu Selections	Options	Descriptions	Page
6.PRINT REPORTS	1.HELP LIST	—	—	You can print lists & reports.	9-3
	2.AUTO DIAL	—	—		
	3.FAX ACTIVITY	—	—		
	4.TRANSMISSION	—	—		
	5.USER SETTINGS	—	—		

4 Initial setup

Getting started

Setting the Paper Type

To get the best print quality, set the MFC for the type of paper you are using.

1 Press **Menu/Set**, **1**, **1**.

2 Press  to select PLAIN, INK JET, GLOSSY or TRANSPARENCY.

Press **Menu/Set**.

3 If you selected GLOSSY, press  to select GLOSSY : 4-COLOR or GLOSSY : 3-COLOR.

Press **Menu/Set**.

GENERAL SETUP 1. PAPER TYPE

 The print quality of black ink varies depending on the kind of glossy paper you are using. Black ink is used when you select GLOSSY : 4-COLOR. If the glossy paper you are using repels the black ink, select GLOSSY : 3-COLOR, which simulates black ink by combining the three ink colors.

4 Press **Stop/Exit**.

 The MFC ejects paper with printed surfaces face up onto the paper tray in the front of the machine. When you use transparencies or glossy paper, remove each sheet immediately to prevent smudging or paper jams.

Setting the Paper Size

You can use three sizes of paper for printing your faxes and copies: A4, letter and legal. When you change the type of paper you load in the MFC, you will need to change the setting for Paper Size at the same time so your MFC can fit an incoming fax on the page.

- 1 Press **Menu/Set, 1, 2.**
- 2 Press  to select LETTER, LEGAL or A4.
Press **Menu/Set.**

GENERAL SETUP
2. PAPER SIZE

- 3 Press **Stop/Exit.**



For PhotoCapture Center and Copy Options, you can also change the paper size to post card size (4" × 6") for the next copy or printout only.

(See *Paper Size* on page 10-9 and *Paper and Print Size* on page 11-9.)

Setting the Date and Time

Your MFC displays the date and time, and if you set up the Station ID it prints on every fax you send. If there is a power failure, you may have to reset the date and time. All other settings will not be affected.

- 1 Press **Menu/Set, 1, 3.**
- 2 Enter the last two digits of the year.
Press **Menu/Set.**

GENERAL SETUP
3. DATE/TIME

- 3 Enter two digits for the month.
Press **Menu/Set.**
(For example, enter 09 for September, or 10 for October.)

DATE/TIME
YEAR : 20XX

- 4 Enter two digits for the day.
Press **Menu/Set.**
(For example, enter 06).

DATE/TIME
MONTH : XX

- 5 Enter the time in 24-Hour format.
Press **Menu/Set.**
(For example, enter 15:25 for 3:25 P.M.)

DATE/TIME
DAY : XX

- 6 Press **Stop/Exit.** The LCD now shows the date and time you set whenever the MFC is in Standby mode.

DATE/TIME
TIME : XX:XX

Setting the Station ID

You should store your name or company name and fax number to be printed on all fax pages that you send.

1 Press **Menu/Set, 1, 4.**

GENERAL SETUP
4.STATION ID

2 Enter your fax number (up to 20 digits).

STATION ID
FAX:

Press **Menu/Set.**

You must enter a fax number to continue (up to 20 digits).



If you do not enter a fax number, you cannot enter any more information.



You can not enter a hyphen.

3 Use the dial pad to enter your name (up to 20 characters).

STATION ID
NAME:

Press **Menu/Set.**

(See *Entering text* on page 4-4.)

4 Press **Stop/Exit.**

The LCD will show the date and time.



If the Station ID has already been programmed, the LCD will ask you to press **1** to make a change or **2** to exit without changing.

Entering text

When you are setting certain functions, such as the Station ID, you may need to type text into the MFC. Most number keys have three or four letters printed below them. The keys for **0**, **#** and ***** do not have printed letters because they are used for special characters.

By pressing the appropriate number key repeatedly, you can access the character you want.

Press Key	one time	two times	three times	four times
2	A	B	C	2
3	D	E	F	3
4	G	H	I	4
5	J	K	L	5
6	M	N	O	6
7	P	Q	R	S
8	T	U	V	8
9	W	X	Y	Z

Inserting spaces

To enter a space, press  once between numbers and twice between characters.

Making corrections

If you entered a letter incorrectly and want to change it, press  to move the cursor after the last correct letter. Then press **Stop/Exit**. All the letters above and to the right of the cursor will be deleted.

Re-enter the correct characters. You can also back up and type over incorrect letters.

Repeating letters

If you need to enter a character that is on the same key as the previous character, press  to move the cursor to the right.

Special characters and symbols

Press *****, **#** or **0**, and then press  to move the cursor under the special character or symbol you want. Then press **Menu/Set** to select it.

Press ***** for (space) ! " # \$ % & ' () * + , - . /

Press **#** for : ; < = > ? @ [] ^ _

Press **0** for É À È Ê Î Ç Ë Ö 0

NOTICE

The Telephone Consumer Protection Act of 1991 makes it unlawful for any person to use a computer or electronic device to send any message via a telephone fax machine unless such messages clearly contain, in a margin at the top or bottom of each transmitted page, or on the first page of the transmission, the date and time it is sent and an identification of the business or other entity or other individual sending the message and the telephone number of the sending machines or such business, other entity or individual.

In order to program this information into your fax machine, complete the steps described on page 4-3.

Setting the Ring Volume

1 Press **Menu/Set, 1, 5, 1.**

2 Press  to select
(OFF, LOW, MED, or HIGH).
Press **Menu/Set.**

VOLUME
1. RING

3 Press **Stop/Exit.**

—OR—

You can adjust the ring volume when your MFC is idle (not being used). You can turn the ring OFF or you can select the ring volume level.

Press  to adjust the volume level. Every time you press a key, the MFC will ring so you can hear the active setting as the LCD shows it. The volume changes with each key press. The new setting will stay until you change it again.

Setting the Beeper Volume

You can change the beeper volume. The default (original) setting is LOW. When the beeper is on, the MFC beeps every time you press a key or make a mistake and when a fax is being sent or received.

1 Press **Menu/Set, 1, 5, 2.**
(LOW, MED, HIGH or OFF)

VOLUME
2. BEEPER

2 Press  to select your option.

3 When the LCD shows the option you want.
Press **Menu/Set.**

4 Press **Stop/Exit.**

Setting the Speaker Volume

You can adjust the speaker volume.

- 1 Press **Menu/Set**, **1**, **5**, **3**.
- 2 Press  to select (OFF, LOW, MED, or HIGH). Press **Menu/Set**.
- 3 Press **Stop/Exit**.

VOLUME
3. SPEAKER

—OR—

You can adjust the speaker volume by pressing **Hook** and  to select a speaker volume level.

Press  to adjust the volume level. The LCD shows the setting you are choosing. Each key press changes the volume to the next setting. The new setting will remain until you change it again.

Turning on Automatic Daylight Savings Time



You can set the MFC to change automatically for Daylight Savings Time. It will reset itself forward one hour in the Spring and backward one hour in the Fall. Make sure you have set the correct day and time in the DATE/TIME setting.

- 1 Press **Menu/Set**, **1**, **6**.
- 2 Press  to select ON (or OFF). Press **Menu/Set**.
- 3 Press **Stop/Exit**.

GENERAL SETUP
6. AUTO DAYLIGHT

Setting the LCD Contrast

You can adjust the LCD contrast for a sharper and more vivid display. If you are having difficulty seeing the LCD from your position, we recommend the following contrast settings for improved viewing.

- 1 Press **Menu/Set, 1, 7.**
- 2 Press  to increase the contrast.
—OR—
Press  to decrease the contrast.
Press **Menu/Set.**
- 3 Press **Stop/Exit.**

GENERAL SETUP
7.LCD CONTRAST



SELECT ↑ ↓ & SET
-■□□□□+

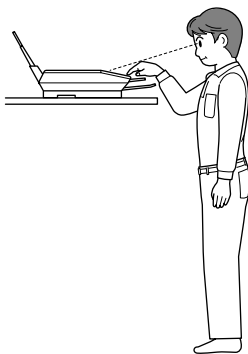

SELECT ↑ ↓ & SET
-■■■□□+

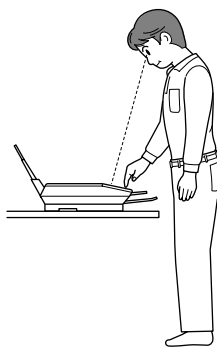

SELECT ↑ ↓ & SET
-■■■□□+

Setting Tone and Pulse dialing mode

- 1 Press **Menu/Set, 1, 8.**
- 2 Press  to select PULSE (or TONE).
Press **Menu/Set.**
- 3 Press **Stop/Exit.**

GENERAL SETUP
8.TONE/PULSE

5 Setup Receive

Basic receiving operations

Choosing the Receive Mode

There are four different Receive Modes for your MFC. You can choose the mode that best suits your needs.

LCD	How it works	When to use it
FAX ONLY (automatic receive)	The MFC automatically answers every call as a fax.	For dedicated fax lines.
FAX/TEL* (fax and telephone) (with an External or Extension Telephone)	The MFC controls the line and automatically answers every call. If the call is a fax it will receive the fax. If the call is not a fax it will ring (pseudo/double ring) for you to pick up the call.	Use this mode if you expect to receive lots of fax messages and few telephone calls. You cannot have an answering machine on the same line, even if it is on a separate wall jack (phone socket) on the same line. You cannot use the telephone company's Voice Mail in this mode.
EXTERNAL TAD (with an External Answering Machine)	The external answering machine (TAD) automatically answers every call. Voice messages are stored on the external TAD. Fax messages are printed.	Use this mode if you have an external answering machine on your phone line. The TAD setting works only with an external answering machine. Ring Delay and F/T Ring Time do not work in this setting.
MANUAL (manual receive) (with an External or Extension Telephone or with Distinctive Ring)	You control the phone line and must answer every call yourself.	Use this mode when you are using a computer modem on the same line or if you don't receive many fax messages or with Distinctive Ring. If you hear fax tones, wait until the machine takes over the call, then hang up. (See <i>Easy Receive</i> on page 5-4.)

* In FAX/TEL mode you must set the Ring Delay and F/T Ring Time. If you have extension phones on the line, keep the Ring Delay set to 4 rings.

To select or change your Receive Mode

- 1 Press **Menu/Set**, **2**, **1**, **1**.
- 2 Press  to select FAX ONLY, FAX/TEL, EXTERNAL TAD or MANUAL.
Press **Menu/Set**.

SETUP RECEIVE
1.RECEIVE MODE

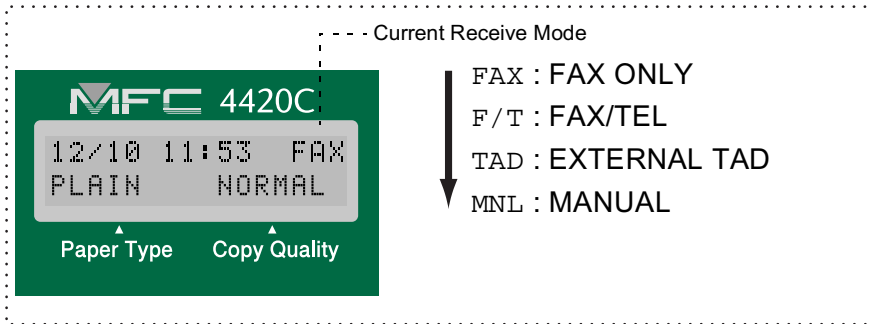

Setting the Ring Delay

The Ring Delay sets the number of times the MFC rings before it answers in FAX ONLY or FAX/TEL mode. If you have extension phones on the same line as the MFC or subscribe to the telephone company's Distinctive Ring service, keep the Ring Delay setting of 4. (See *Easy Receive* on page 5-4 and *Operation from extension telephones* on page 5-6.)

- 1 Press **Menu/Set**, **2**, **1**, **2**.
- 2 Press  to select how many times the line rings before the MFC answers (00-04).
Press **Menu/Set**.
(If you select 00, the line won't ring at all.)
- 3 Press **Stop/Exit**.

SETUP RECEIVE
2.RING DELAY

Setting the F/T Ring Time (FAX/TEL mode only)

If you set the Receive Mode to FAX/TEL, you'll need to decide how long the MFC will signal you with its special pseudo/double-ring when you have a voice call. (If it's a fax call, the MFC prints the fax.) This ringing happens after the initial ringing from the phone company. Only the fax machine rings (for 20, 30, 40 or 70 seconds) and no other phones on the same line will ring with the special pseudo/double-ring. However, you can answer the call on any extension phone (in a separate wall jack/phone socket) on the same line as the MFC. (See *Operation from extension telephones* on page 5-6.)

1 Press **Menu/Set**, **2**, **1**, **3**.

2 Press  to select how long the MFC will ring to alert you that you have a voice call.
Press **Menu/Set**.

SETUP RECEIVE 3.F/T RING TIME

3 Press **Stop/Exit**.



Even if the caller hangs up during the pseudo/double-ringing, the machine will continue to ring for the set time.

Easy Receive

When you use this feature, you don't have to press **Fax Start** or the Fax Receive Code * **5 1** when you answer a fax call. Selecting **ON** allows the MFC to receive fax calls automatically, even if you lift the handset of an extension or external phone. When you see **RECEIVING** on the LCD or when you hear "chirps" through the handset of an extension phone connected to another wall jack (phone socket), just replace the handset and your MFC will do the rest. Selecting **OFF** means you'll have to activate the MFC yourself by lifting the handset of an external or extension phone, and then press **Fax Start** on the MFC—**OR**—by pressing * **5 1** if you are not at your MFC. (See *Operation from extension telephones* on page 5-6.)



If this feature is set to **ON**, but your MFC doesn't connect a fax call when you lift a phone handset, press the Fax Receive code * **5 1**.

If you send faxes from a computer on the same phone line and the MFC intercepts them, set Easy Receive to **OFF**.

- 1 Press **Menu/Set**, **2**, **1**, **4**.
- 2 Use  to select **ON** (or **OFF**). Press **Menu/Set**.
- 3 Press **Stop/Exit**.

SETUP RECEIVE 4.EASY RECEIVE

Printing a reduced incoming fax (Auto Reduction)

If you choose **ON**, the MFC automatically reduces an incoming fax to fit on one page of letter, legal or A4 size paper, regardless of the paper size of the original. The MFC calculates the reduction ratio by using the page size of the original and your Paper Size setting (**Menu, 1, 2**).

- 1** Press **Menu/Set, 2, 1, 6**.
- 2** Use  to select **ON** (or **OFF**). Press **Menu/Set**.
- 3** Press **Stop/Exit**.

SETUP RECEIVE
6.AUTO REDUCTION



If you receive faxes that are split onto two pages, turn on this setting.

Receiving a fax at the end of a conversation

At the end of a conversation you can ask the other party to fax you information before you both hang up.

- 1** Ask the other party to place the original in their machine and to press **Start**. Tell the other party to wait until your MFC sends receiving tones (chirps) before hanging up.
- 2** When you hear the other machine's CNG tones (beeps), press **Fax Start**.

The LCD shows:

- 3** Press **2** to receive the fax.
- 4** Replace the handset.

1.SEND 2.RECEIVE

Advanced receiving operations

Operation from extension telephones

If you answer a fax call on an extension telephone, or an external telephone in the EXT. jack, you can make your MFC take the call by using the Fax Receive Code. When you press the Fax Receive Code * 5 1, the MFC starts to receive a fax.

(See *Easy Receive* on page 5-4.)

If the MFC answers a voice call and pseudo/double-rings for you to take over, use the Telephone Answer Code # 5 1 to take the call at an extension phone. (See *Setting the F/T Ring Time (FAX/TEL mode only)* on page 5-3.)

If you answer a call and no one is on the line, you should assume that you're receiving a manual fax.

- At an extension phone (on a separate telephone wall jack/socket), press * 5 1, wait for fax-receiving tones (chirps), and then hang up.
- At an external phone (connected to the MFC's EXT jack), press * 5 1 and wait for the phone to be disconnected before you hang up (the LCD shows RECEIVING).

Your caller will have to press **Start** to send the fax.

For FAX/TEL mode only

When the MFC is in FAX/TEL mode, it will use the F/T Ring Time (pseudo/double-ringing) to alert you to pick up a voice call.

If you're at an extension or external phone, you'll need to lift the handset during the F/T Ring Time and then press # 5 1 between the double rings. If no one is on the line, or if someone wants to send you a fax, send the call back to the machine by pressing * 5 1.

Using a cordless external handset

If your cordless telephone is connected to the EXT. jack of the MFC and you typically carry the cordless handset elsewhere, it is easier to answer calls during the Ring Delay. If you let the MFC answer first, you will have to answer using the cordless and then go to the MFC so you can press **Hook** to transfer the call to the cordless handset.

Changing the remote codes

Remote Codes might not work with some telephone systems. The preset Fax Receive Code is * **5 1**. The preset Telephone Answer Code is **# 5 1**.

 If you are always disconnected when accessing your external TAD remotely, try changing the Fax Receive Code and Telephone Answer Code to other three-digit codes (such as **###** and **9 9 9**).

- 1 Press **Menu/Set**, **2**, **1**, **5**.
- 2 Press  to select ON (or OFF).
Press **Menu/Set**.
- 3 If you want to, enter a new Fax Receive Code.
Press **Menu/Set**.
- 4 If you want to, enter a new Telephone Answer Code.
Press **Menu/Set**.
- 5 Press **Stop/Exit**.

SETUP RECEIVE
5.REMOTE CODE

Printing a fax from the memory

If you set Fax Storage to ON for Remote Retrieval, you can still print a fax from the memory when you are at your MFC. (See *Setting Fax Storage* on page 8-1.)

- 1 Press **Menu/Set**, **2**, **5**, **4**.
- 2 Press **Fax Start**.
- 3 After printing has finished,
press **Stop/Exit**.

REMOTE FAX OPT
4.PRINT FAX

Polling

Polling is the process of retrieving faxes from another fax machine. You can use your MFC to 'poll' other machines, or you can have someone poll your MFC.

Everyone who is involved in Polling needs to set up their fax machines for Polling. When someone polls your MFC to receive a fax, they pay for the call. If you poll someone's fax machine to receive a fax, you pay for the call.



Some fax machines do not respond to the Polling feature.

Setting up Polling Receive

Polling Receive is when you call another fax machine to receive a fax from it.

- 1 Press **Menu/Set, 2, 1, 7.**
- 2 Press  to select ON (or OFF).
Press **Menu/Set.**
- 3 Enter the fax number you are polling.
- 4 Press **Fax Start.**
The LCD shows DIALING.

SETUP RECEIVE
7.POLLING RX

Setting up Sequential Polling Receive

Your MFC can ask for faxes from several fax units in a single operation (Sequential Polling Receive). Afterwards, a Sequential Polling Report will be printed.

- 1 Press **Menu/Set, 2, 1, 7.**
Press  to select ON (or OFF).
Press **Menu/Set.**
- 2 Enter the fax machines you want to poll using Speed Dial, a Group or the dial pad. You must press **Menu/Set** between each fax number.
- 3 Press **Fax Start.** Your MFC will poll each number or Group number in turn to receive a fax.

SETUP RECEIVE
7.POLLING RX



Press **Stop/Exit** while the machine is dialing to cancel the polling process.

To cancel all sequential polling receive jobs, press **Menu/Set, 2, 6.** (See *Canceling a scheduled job* on page 6-10.)

Telephone services

Your MFC supports the Distinctive Ring telephone service that some telephone companies offer.



If you have Voice Mail, Call Waiting, Call Waiting/Call ID, RingMaster, an answering service, an alarm system or other custom features on your telephone line, it may affect the way your MFC works. (See *Custom features on a single line.* on page 22-7.)

If you have Voice Mail on your phone line, please read the following carefully.

Distinctive Ring

Brother uses the term 'Distinctive Ring' but different telephone companies have other names for this service such as SmartRing, RingMaster, Teen-Ring, Indent-a-Call or Indent-a-Ring.

What does your telephone company's 'Distinctive Ring' do?

Your telephone company's Distinctive Ring service allows you to have more than one number on the same phone line. **If you need more than one phone number, it is cheaper than paying for an extra line.** Each phone number has its own distinctive ring pattern, so you will know which phone number is ringing. This is one way you can have a separate phone number for your MFC.



Please call your telephone company for availability and rates.

What does Brother's 'Distinctive Ring' do?

The Brother MFC has a Distinctive Ring feature that allows you to use your MFC to take full advantage of the telephone company's Distinctive Ring service. The new phone number on your line can just receive faxes.



You must pay for your telephone company's Distinctive Ring service before you program the MFC to work with it.

Do you have Voice Mail?





If you have Voice Mail on the phone line that you will install your new MFC on, *there is a strong possibility that Voice Mail and the MFC will conflict with each other while receiving incoming calls.* **However, this Distinctive Ring feature allows you to use more than one number on your line, so both Voice Mail and the MFC can work together without any problems.** If each one has a separate phone number, neither will interfere with the other's operations.

If you decide to get the Distinctive Ring service from the telephone company, you will need to follow the directions below to 'register' the new Distinctive Ring pattern they give you. This is so your MFC can recognize its incoming calls.

 You can change or cancel the Distinctive Ring pattern at any time. You can switch it off temporarily, and turn it back on later. When you get a new fax number, make sure you reset this feature.

Before you choose the ring pattern to register

You can only register one Distinctive Ring pattern with the MFC. Some ring patterns cannot be registered. The ring patterns below are supported by your Brother MFC. Register the one your telephone company gives you.

Ring Pattern	Rings	
1	long-long	
2	short-long-short	
3	short-short-long	
4	very long (normal pattern)	



 If the ring pattern you received is not on this chart, **please call your telephone company and ask for one that is shown.**

- The MFC will only answer calls to its registered number.
- The first two rings are silent on the MFC. This is because the fax must «listen» to the ring pattern (to compare it to the pattern that was 'registered'). (Other telephones on the same line will ring.)
- If you program the MFC properly, it will recognize the registered ring pattern of the 'fax number' within 2 ring patterns and then answer with a fax tone. When the 'voice number' is called, the MFC will not answer.

Registering the Distinctive Ring pattern

Very important

After you have set the Distinctive Ring feature to ON, the receive mode is set to **MANUAL** automatically. Unless you have a TAD or Voice Mail set up on the Distinctive Ring number, **MANUAL** mode means you must answer all the calls yourself. You can not change the receive mode to the other mode while the Distinctive Ring is set to on.

- 1** Press **Menu/Set, 2, 0, 1**.
- 2** Press  to select **SET?**.
Press **Menu/Set**.
- 3** Press  to select the stored ring pattern you want to use.
Press **Menu/Set**.
(You will hear each pattern as you scroll through the four patterns. Make sure you choose the pattern that the telephone company gave you.)
- 4** Press **Stop/Exit**.
Distinctive Ring is now set to on.

Turning off the Distinctive Ring

- 1** Press **Menu/Set, 2, 0, 1**.
- 2** Press  to select **OFF**.
Press **Menu/Set**.
- 3** Press **Stop/Exit**.

Caller ID



The Caller ID feature lets you use the Caller ID subscriber service offered by many local telephone companies. This service provides you, by means of the LCD, the name or telephone number of your caller as the line rings.

After a few rings, the LCD shows the telephone number of your caller (or name, if available). Once you pick up the handset, the Caller ID information disappears from the LCD, but the call information remains stored in the Caller ID memory.

- You will see the first 16 characters of the number (or name).
- **OUT OF AREA** display means call originated outside your Caller ID service area.
- **PRIVATE CALL** display means the caller has intentionally blocked transmission of information.
- **CALL PICKUP** display remains on the LCD when no Caller ID information was transmitted.

If both the name and number are received, the LCD shows only the name. You can print a list of Caller ID information received by your MFC. (See *Printing Caller ID List* on page 5-13.)

Caller ID service varies with different carriers. Call your local telephone company to determine the kind of service available in your area.

Viewing Caller ID List

Caller ID memory stores information for up to thirty calls; when the thirty-first call comes in, information about the first call is erased. You can scroll through Caller ID information to review those calls made to your MFC.

1 Press **Menu/Set, 2, 0, 2.**

2 Press  to select `DISPLAY #.`
Press **Menu/Set.**

TEL SERVICE 2. CALLER ID

If the name was not received, it will not be displayed.

3 Press  to scroll through the Caller ID memory to select the Caller ID you want to view, and then press **Menu/Set.** The LCD shows the caller's name and number and the date and time of the call.

4 Press  to return to the Caller ID listing.

—OR—

Press **Stop/Exit.**

Printing Caller ID List

1 Press **Menu/Set, 2, 0, 2.**

2 Press  to select
`PRINT REPORT?.`
Press **Menu/Set.**

TEL SERVICE 2. CALLER ID

3 Press **Fax Start.**

4 After printing has finished,
press **Stop/Exit**

6 Setup Send

How to Dial

There are three ways to dial.

Manual Dialing

Press all of the digits of the phone or fax number.

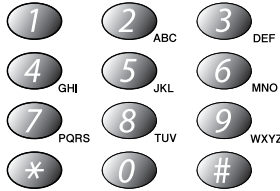

Speed Dialing

Press **Search/Speed Dial**, #, and then the two digit Speed Dial number. (See *Storing Speed Dial numbers* on page 7-1.)

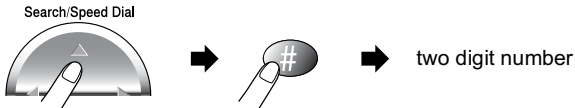

Search

You can search for names you have stored in the Speed Dial memory. Press **Search/Speed Dial** and navigation key to search. (See *Storing Speed Dial numbers* on page 7-1.)

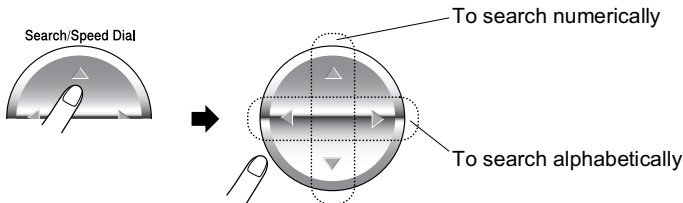

How to Fax

Automatic Transmission

You can use the scanner glass to fax pages of a book or one page at a time. Originals can be up to letter or A4 size (8.5 inches to 11.7 inches).

- 1 Lift the document cover.

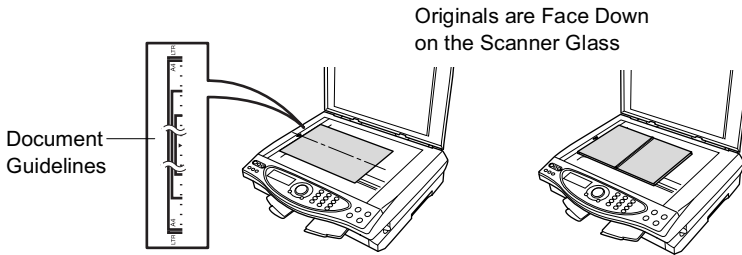

- 2 Using the document guidelines on the left, center the original face down on the scanner glass.
- 3 Close the document cover.

! If the original is a book or is thick lift the cover up. Do not slam the cover or press on it.

- 4 Dial the fax number.
Press **Fax Start**.

MEMORY #001 97%
PLAIN NORMAL

The MFC starts scanning the first page.

- 5 To send a single page, press **2** (or press **Fax Start** again). The MFC starts sending the original.

NEXT PAGE?
1. YES 2. NO (DIAL)

—OR—

To send more than one page, press **1** and go to Step 6.

- 6 Place the next page on the scanner glass.

SET NEXT PAGE
THEN PRESS SET

Press **Menu/Set**.

The MFC starts scanning. (Repeat Steps 5 and 6 for each additional page.)

Press **Stop/Exit** to cancel.



If the memory is full and you are faxing a single page, it will be sent in real time.

Faxing A4 size originals from the scanner glass

When originals are A4 size, you need to set Scan Glass Size to A4. If you do not, the bottom portion of the faxes will be missing.

- 1 Press **Menu/Set**, **2**, **2**, **0**.
- 2 Press  to select A4 (or LETTER).
Press **Menu/Set**.
- 3 Press **Stop/Exit**.

SETUP SEND 0.SCAN SIZE

Out of memory message

If you get an OUT OF MEMORY message while scanning the first page of a fax, press **Stop/Exit** to cancel the scan. If you get an OUT OF MEMORY message while scanning a subsequent page, you will have the option to press **Fax Start** to send the pages scanned so far, or to press **Stop/Exit** to cancel the operation.

Manual Transmission

Manual transmission lets you hear the dialing, ringing and fax-receiving tones while sending a fax.

- 1 Place the original face down on the scanner glass.
- 2 Pick up the handset of the external phone and listen for a dial tone.
—OR—
Press **Hook** and listen for a dial tone.
- 3 On the external phone, dial the fax number you want to call. If you pressed **Hook**, dial using the MFC control panel.
- 4 When you hear the fax tone, press **Fax Start**.
- 5 Press **1** to send a fax.
- 6 If you picked up the handset of the external phone, replace the handset.

1.SEND 2.RECEIVE



You can not send multiple pages.

Sending a fax at the end of a conversation

At the end of a conversation you can send a fax to the other party before you both hang up.

1 Ask the other party to wait for fax tones (beeps) and then press **Start** before hanging up.

2 Place the original on the scanner glass.

Press **Fax Start**.

The LCD shows:

1 . SEND 2 . RECEIVE

3 Press **1** to send the fax.

4 Replace the handset.

Basic sending operations

Sending faxes using multiple settings

When you send a fax you can choose any combination of these settings: contrast, resolution, overseas mode, delayed fax timer, polling transmission or real time transmission. After each setting is accepted, the LCD will ask if you want to enter more settings:

Press **1** to select more settings. The LCD will return to the **SETUP SEND** menu.

OTHER SETTINGS?
1. YES 2. NO

—OR—

Press **2** if you have finished choosing settings and go to the next step.

Contrast

If your original is very light or very dark, you may want to set the contrast.

Use **S. LIGHT** to make the document darker.

Use **S. DARK** to make the document lighter.

- 1 Place the original face down on the scanner glass.

SETUP SEND
1. CONTRAST

Press **Menu/Set, 2, 2, 1**.

- 2 Press  to select **AUTO**, **S. LIGHT** or **S. DARK**. Press **Menu/Set**.

- 3 Press **1** if you want to choose more settings and the LCD will return to the **SETUP SEND** menu.

OTHER SETTINGS?
1. YES 2. NO

—OR—

Press **2** if you have finished choosing settings for this page, and then go to Step 4.

- 4 Enter a fax number.

- 5 Press **Fax Start** to send the fax.

The MFC starts scanning the first page.

- 6** To send a single page, press **2** (or press **Fax Start** again).
The MFC starts sending the original.

NEXT PAGE?
1. YES 2. NO (DIAL)

—OR—

To send more than one page, press **1** and go to Step 7.

- 7** Place the next page on the scanner glass.

SET NEXT PAGE
THEN PRESS SET

Press **Menu/Set**.

The MFC starts scanning and returns to Step 6. (Repeat Step 6 and 7 for each additional page).

Fax resolution

When you have an original on the scanner glass you can use the **Fax Resolution** key to change the setting temporarily (for this fax only). Press **Fax Resolution** repeatedly until the LCD shows the setting you want.

—OR—

You can change the default setting.

- 1** Press **Menu/Set, 2, 2, 2**.
2 Press  to select the resolution you want.
Press **Menu/Set**.

SETUP SEND
2. FAX RESOLUTION

- 3** Press **Stop/Exit**.

STANDARD _____ Suitable for most typed documents.

FINE _____ Good for small print and transmits a little slower than Standard resolution.

S. FINE _____ Good for small print or artwork and transmits slower than Fine resolution.

PHOTO _____ Use when the original has varying shades of gray. This has the slowest transmission time.

COLOR STD _____ Use to send the original in color.

COLOR FINE _____ Better quality than COLOR STD. Use to send the original as Art-work or photographs in color.

Color fax transmission

Your MFC can send a color fax to machines that support this feature. However, color files cannot be stored in the memory, so Delayed fax and Polling Transmission features are not available.

- 1 Place the original face down on the scanner glass.
- 2 Press **Fax Resolution** to select the `COLOR STD` or `COLOR FINE`.
- 3 Enter the fax number using the dial pad, Speed Dial or Search.
- 4 Press **Fax Start**.



When you send a color fax, the MFC will send it in real time (even if `REAL TIME TX` is set to `OFF`).



You can not send multiple pages.

Manual and automatic fax redial

If you are sending a fax manually and the line is busy, press **Redial/Pause**, and then press **Fax Start** to try again. If you want to make a second call to the last number dialed, you can save time by pressing **Redial/Pause** and **Fax Start**.

Redial/Pause only works if you dialed from the control panel.

If you are sending a fax automatically and the line is busy, the MFC will automatically redial one time after five minutes.

Dual Access (Not available for color faxes)

You can dial a number, and begin scanning the fax into memory—even when the MFC is receiving, sending or printing a fax from memory. The LCD shows the new job number and available memory.



If you get a **OUT OF MEMORY** message while scanning the first page of a fax, press **Stop/Exit** to cancel scanning. If you get a **OUT OF MEMORY** message while scanning a subsequent page, you can press **Fax Start** to send the pages scanned so far, or press **Stop/Exit** to cancel the operation.

1 Place the original face down on the scanner glass.

2 Enter the fax number.

3 Press **Fax Start** to send the fax.

The MFC starts scanning the first page and the LCD shows the job number (#XXX) of the fax and how much memory is available.

4 To send a single page, press **2** (or press **Fax Start** again).

NEXT PAGE?
1. YES 2. NO (DIAL)

The MFC starts sending the original.
—OR—

To send more than one page, press **1** and go to Step 5.

5 Place the next page on the scanner glass. Press **Menu/Set**.

SET NEXT PAGE
THEN PRESS SET

The MFC starts scanning, and then returns to Step 4. (Repeat Steps 4 and 5 for each additional page). You can repeat Steps 1 to 5 for the next fax.



Your MFC normally uses Dual Access. However, to send a color fax, the MFC will send the original in real time (even if **Real Time TX** is **OFF**).

The number of pages you can scan into the memory will vary depending on the data that is printed on them.

Real Time Transmission

When you are sending a fax, the MFC will scan the originals into the memory before sending. Then, as soon as the phone line is free, the MFC will start dialing and sending.

If the memory becomes full, the MFC will send the original in real time (even if `REAL TIME TX` is set to `OFF`).

If you want to fax multiple pages, use Dual Access. (See *Dual Access (Not available for color faxes)* on page 6-8.)

Sometimes, you may want to send an important original immediately, without waiting for memory transmission.

You can set `REAL TIME TX` to `ON` for all faxes or only for the next fax.

1 Place the original face down on the scanner glass.

2 Press **Menu/Set, 2, 2, 5**.

SETUP SEND
5.REAL TIME TX

3 To change the default setting, press

 to select `ON` (or `OFF`).

Press **Menu/Set**.

Go to Step 5.

—OR—

For the next fax transmission only, press  to select `NEXT FAX ONLY`.

Press **Menu/Set**.

4 Press  to select `ON` (or `OFF`).

Press **Menu/Set**.

5 Press **1** if you want to choose more settings and the LCD will return to the `SETUP SEND` menu.

OTHER SETTINGS?
1.YES 2.NO

—OR—

Press **2** if you have finished choosing settings for this page, and then go to Step 6.

6 Enter the fax number.

7 Press **Fax Start** to send the fax.



If you are sending a color Fax, the MFC will send it in real time (even if `REAL TIME TX` is set to `OFF`).

Checking job status

Check which jobs are still waiting in the memory to be sent. (If there are no jobs, the LCD shows NO JOB WAITING.)

(See *Canceling a job while scanning, dialing and sending the original* on page 6-10.)

- 1 Press **Menu/Set, 2, 6**.
- 2 If you have more than one job waiting, press  to scroll through the list.
- 3 Press **Stop/Exit**.

FAX 6.REMAINING JOBS

Canceling a job while scanning, dialing and sending the original

You can cancel a job while you are scanning it into memory by pressing **Stop/Exit**.

You can also cancel a job while the MFC are dialing or sending the original by pressing **Stop/Exit**.

Canceling a scheduled job

You can cancel a fax job that is waiting in memory. (See *Checking job status* on page 6-10.)

- 1 Press **Menu/Set, 2, 6**.
Any jobs that are waiting will appear on the LCD.
- 2 If you have more than two jobs waiting, press  to select the job you want to cancel.
Press **Menu/Set**.
—OR—
If you only have one job waiting, go to Step 3.
- 3 Press **1** to cancel.
—OR—
Press **2** to exit without canceling.
To cancel another job go to Step 2.
- 4 Press **Stop/Exit**.

FAX 6.REMAINING JOBS

Advanced sending operations

Broadcasting (Not available for color faxes)

Broadcasting is when the same fax message is automatically sent to more than one fax number. Using the **Menu/Set** key, you can include Groups, Speed Dial numbers and up to 50 manually dialed numbers. If you did not use up any of the numbers for Groups, access codes or credit card numbers, you can 'broadcast' faxes to as many as 130 different numbers. However, the available memory will vary depending on the types of jobs in the memory and the number of locations used for broadcasting. If you broadcast to more than the maximum numbers available, you will not be able to use Dual Access and the Timer.

To include Speed Dial numbers and manually dialed numbers in the same broadcast, you must press **Menu/Set** between each of the numbers. Use **Search/Speed Dial** to help you choose the numbers easily.

(See *Setting up Groups for Broadcasting* on page 7-3.)

After the broadcast is finished, a Broadcast Report will be printed to let you know the results.

- Enter the long dialing sequence numbers as you would normally, but remember that each Speed Dial number counts as one number, so the number of locations you can store becomes limited.
 - If the line is busy a connection cannot be made so the MFC will redial the number.
 - If the memory is full, press **Stop/Exit** to stop the job or if more than one page has been scanned, press **Fax Start** to send the portion that is in the memory.
- 1 Place the original face down on the scanner glass.
 - 2 Enter a number using Speed Dial, a Group number, Search or the dial pad.
(Example: Group number)
 - 3 Press **Menu/Set**. You will be asked to press the next number.

4 Enter the next number.
(Example: Speed Dial number)

5 Press **Menu/Set**.

6 Enter another fax number.
(Example: Manual dialing using the dial pad.)

7 Press **Fax Start**.

8 To send a single page,
press **2** (or press **Fax Start** again).

NEXT PAGE?
1.YES 2.NO(DIAL)

The MFC starts sending the original.

—OR—

To send more than one page, press **1** and go to Step 9.

9 Place the next page on the scanner
glass.

SET NEXT PAGE
THEN PRESS SET

Press **Menu/Set**.

The MFC starts scanning and returns to Step 8. (Repeat Step 8 and 9 for each additional page).

Overseas Mode

If you are having difficulty sending a fax overseas due to possible interference on the phone line, we recommend that you turn on the Overseas Mode. After you send a fax using this feature, the feature will turn itself off.

- 1** Place the original face down on the scanner glass.

SETUP SEND
7. OVERSEAS MODE

- 2** Press **Menu/Set, 2, 2, 7**.

- 3** Press  to select ON (or OFF).
Press **Menu/Set**.

- 4** Press **1** if you want to choose more settings and the LCD will return to the SETUP SEND menu.

—OR—

Press **2** if you have finished choosing settings, and then go to Step 5

- 5** Enter the fax number you're calling.

- 6** Press **Fax Start**.

- 7** To send a single page,
press **2** (or press **Fax Start** again).

NEXT PAGE?
1. YES 2. NO (DIAL)

The MFC starts sending the original.

—OR—

To send more than one page, press **1** and go to Step 8.

- 8** Place the next page on the scanner glass.

SET NEXT PAGE
THEN PRESS SET

Press **Menu/Set**.

The MFC starts scanning and returns to Step 7. (Repeat Step 7 and 8 for each additional page).

Delayed Fax (Not available for color faxes)

During the day you can store up to 50 faxes in the memory to be sent within 24 hours. These faxes will be sent at the time of day you enter in Step 3. Press **Menu/Set** to accept it, or enter another time for the faxes to be sent.

- 1** Place the original face down on the scanner glass. SETUP SEND
3.DELAYED FAX
- 2** Press **Menu/Set**, **2**, **2**, **3**.
- 3** Enter the time you want the fax to be sent (in 24-hour format). Press **Menu/Set**.
(For example, enter 19:45 for 7:45 PM.)
- 4** Press **1** if you want to choose more settings and the LCD will return to the SETUP SEND menu.
—OR—
Press **2** if you have finished choosing settings, and then go to Step 5.
- 5** Enter the fax number.
- 6** Press **Fax Start**.
- 7** To send a single page, press **2** (or press **Fax Start** again). NEXT PAGE?
1.YES 2.NO(DIAL)
—OR—
To send more than one page, press **1** and go to Step 8.
- 8** Place the next page on the scanner glass. SET NEXT PAGE
THEN PRESS SET
Press **Menu/Set**.
The MFC starts scanning and returns to Step 7. (Repeat Step 7 and 8 for each additional page).



The number of pages you can scan into the memory depends on the amount of data that is printed on each page.

Delayed Batch Transmission (Not available for color faxes)



Before sending the delayed faxes, your MFC will economize by sorting all the documents in the memory by destination and scheduled time. All delayed faxes that are scheduled to be sent at the same time to the same fax number will be sent as one fax.

- 1 Press **Menu/Set**, **2**, **2**, **4**.
- 2 Press  to select ON (or OFF).
Press **Menu/Set**.
- 3 Press **Stop/Exit**.

SETUP SEND
4.BATCH TX

Setting up Polled Transmission (Not available for color faxes)

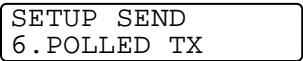
Polled Transmission is when you set up your MFC to wait with an original so another fax machine can retrieve it.

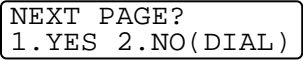
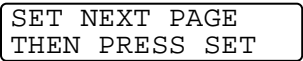
- 1** Place the original that is going to be retrieved face down on the scanner glass.

- 2** Press **Menu/Set, 2, 2, 6.**
- 3** Press  to choose ON (or OFF). Press **Menu/Set.**
- 4** Press **1** if you want to choose more settings and the LCD will return to the SETUP SEND menu.
—OR—
Press **2** if you have finished choosing settings, and go to step 5.
- 5** Press **Fax Start.**
- 6** To send a single page, press **2** (or press **Fax Start** again).
The MFC starts sending the original.
—OR—
To send more than one page, press **1** and go to Step 7.

- 7** Place the next page on the scanner glass.
Press **Menu/Set.**

- 8** The MFC starts scanning and returns to Step 6. (Repeat Step 6 and 7 for each additional page).



If Real Time Transmission is set to OFF, your original will be waiting in memory until polled. This information is available for retrieval by any other fax machine unless it is deleted from the memory. (See *Canceling a scheduled job* on page 6-10.)

7

Auto Dial numbers and Dialing options

Storing numbers for easy dialing

You can set up your MFC to do two types of easy dialing: Speed Dial and Groups for Broadcasting faxes.



If you lose electrical power, the auto dial numbers that are in the memory will not be lost.

Storing Speed Dial numbers

You can store Speed Dial numbers, so that when you dial you will only have to press a few keys (**Search/Speed Dial**, **#**, the two-digit number, and **Fax Start**). The MFC can store 80 Speed Dial numbers.



(USA Only) Speed Dial number 01 has been programmed for the Brother fax back system. You can change it if you want to.

1 Press **Menu/Set**, **2**, **3**, **1**.

SET AUTO DIAL
1 . SPEED-DIAL

2 Use the dial pad to enter a two-digit Speed Dial number (01-80).
(For example, press **0 5**.)
Press **Menu/Set**.

SPEED-DIAL
SPEED-DIAL? #_

3 Enter the number (up to 20 digits).
Press **Menu/Set**.

SPEED-DIAL
#05 : _

4 Use the dial pad to enter the name (up to 15 characters).
Press **Menu/Set**.

SPEED-DIAL
NAME : _

(You can use the chart on page 4-4 to help you enter letters.)

—OR—

Press **Menu/Set** to store the number without a name.

5 Go to Step 2 to store another Speed Dial number.

—OR—

Press **Stop/Exit**.

Changing Speed Dial numbers

If you try to store a Speed Dial number where a number is already stored, the LCD will show the name stored there (or number) and will ask you to do one of the following:

- 1 Press **1** to change the stored number.

#05:XXXXXXXX
1.CHANGE 2.EXIT

—OR—

Press **2** to exit without making a change.

- 2 Enter a new number.

Press **Menu/Set**.

- If you want to erase the whole number or whole name, press **Stop/Exit** when the cursor is under the first the digits or letters. The characters above and to the right of the cursor will be deleted.

- If you want to change a character, use  to position the cursor under the character you want to change, and then type over it.

- 3 Follow the directions beginning at Step 4 in Storing Speed Dial numbers on the previous page.

Setting up Groups for Broadcasting

Groups allow you to send the same fax message to many fax numbers by pressing only a few keys (**Search/Speed Dial**, **#**, the two-digit number, and **Fax Start**). First, you'll need to store each fax number as a Speed Dial number.

Then, you can combine them into a Group. Each Group uses up a Speed Dial number. You can have up to six Groups, or you can assign up to 79 numbers to one large Group.

(See *Storing Speed Dial numbers* on page 7-1 and *Broadcasting* (Not available for color faxes) on page 6-11.)

1 Press **Menu/Set**, **2**, **3**, **2**.

```
SET AUTO DIAL
2.SETUP GROUPS
```

2 Use the dial pad to enter the two-digit Speed Dial number where you want to store the Group. Press **Menu/Set**.
(For example, press **07** and **Menu/Set**.)

```
SETUP GROUPS
SPEED DIAL? #
```

```
SETUP GROUPS
SPEED-DIAL? #07
```

3 Use the dial pad to enter the Group number. Press **Menu/Set**.
(For example, press **1** for Group 1.)

```
SETUP GROUPS
SETUP GROUP:G01
```



The Group number must be between 1 and 6.

4 To include Speed Dial numbers in the Group, press them as follows:
(For example, for Speed Dial numbers 05 and 09. Press **Search/Speed Dial**, **05**, **Search/Speed Dial**, **09**. The LCD shows: #05#09.)

```
SETUP GROUPS
G01:#05#09
```

5 Press **Menu/Set** to accept the Speed Dial numbers for this Group.

6 Use the dial pad and the chart on page 4-3 to enter a name for the Group. Press **Menu/Set**.
(For example, type NEW CLIENTS).

```
SETUP GROUPS
NAME :
```

7 Press **Stop/Exit**.



You can print a list of all the Speed Dial numbers.
(See *Printing reports* on page 9-1.)

Dialing options

Access codes and credit card numbers

Sometimes you may want to choose from several long distance carriers when you make a call. Rates may vary depending on the time and destination. To take advantage of low rates, you can store the access codes or long-distance carriers and credit card numbers as Speed-Dial numbers. You can store these long dialing sequences by dividing them and setting them up on separate keys in any combination. You can even include manual dialing using the dial pad. The combined number will be dialed in the order that you entered it as soon as you press **Fax Start**.

(See *Storing Speed Dial numbers* on page 7-1.)

For example, you can store '555' on Speed Dial #03 and '7000' on Speed Dial #02. If you press **Search/Speed Dial, #03, Search/Speed Dial, #02, and Fax Start**, you will dial '555-7000'.

To temporarily change a number, you can substitute part of the number with manual dialing using the dial pad.

For example, to change the number to 555-7001 you could press **Search/Speed Dial, #03** and then press **7001** using the dialing pad.



If you must wait for another dial tone or signal at any point in the dialing sequence, store a pause there in the number by pressing **Redial/Pause**. Each key press adds a 3.5-second delay.

Pause

Press **Redial/Pause** to insert a 3.5-second pause between numbers. If you are dialing overseas, you can press **Redial/Pause** as many times as needed to increase the length of the pause.

Fax Redial

If you're sending a fax manually and the line is busy, press **Redial/Pause** to try again. Any time you want to make a second call to the last number dialed, press **Redial/Pause** to save time.

If you're sending a fax automatically and the line is busy, the MFC will automatically redial one time five minutes after the transmission.

Tone or Pulse

If you have a Pulse dialing service, but need to send Tone signals (for example, for telephone banking), follow the instructions below. If you have Touch Tone service, you will not need this feature to send tone signals.

- 1** Lift the handset of an external phone.
- 2** Press **#**. Any digits dialed after this will send tone signals.
- 3** When you hang up, the MFC will return to the Pulse dialing service.

8

Remote fax options

(Not available for color faxes)

Setting Fax Storage

If you set Fax Storage to ON, you will be able to retrieve fax messages from another location using Fax Forwarding, Paging, or Remote Retrieval operations. The LCD will show when you have a fax stored in memory.

- 1 Press **Menu/Set, 2, 5, 2**.
Press  to select ON (or OFF).
Press **Menu/Set**.

REMOTE FAX OPT
2.FAX STORAGE

- 2 Press **Stop/Exit**.



If there are faxes in the memory when you turn Fax Storage OFF, the LCD will ask if you want to erase the faxes from the memory.

ERASE ALL FAX?
1.YES 2.NO

If you press **1**, all fax data is erased and Fax Storage is turned off.

If you press **2**, faxes are not erased and Fax Storage stays on.

(See *Printing a fax from the memory* on page 5-7.)

Backup Print

If you've set FAX STORAGE to ON, your MFC automatically prints faxes as they are received into the memory.

This is a safety feature in case the power goes off so you won't lose your messages.

Fax Forwarding/Paging



*You cannot use Paging and Fax Forwarding at the same time.
You cannot use Paging and Fax Forwarding when Fax Storage
is set to OFF.*

Programming a Fax Forwarding number

When Fax Forwarding is set to ON, your MFC stores received faxes in the memory. Then it dials the fax number you've programmed and forwards the fax message.

1 Press **Menu/Set, 2, 5, 1**.

REMOTE FAX OPT
1.FAX FWD/PAGING

2 Press  until the LCD shows
FAX FORWARD?.

FAX FWD/PAGING
FAX FORWARD?

Press **Menu/Set**.

The LCD will ask you to enter the fax number to which faxes will be forwarded.

3 Enter the forwarding number (up to
20 digits).

FAX FORWARD
#: _

Press **Menu/Set**.

4 Press **Stop/Exit**.

Programming your pager number

When Paging is selected, your MFC dials the pager number you've programmed, and then dials your Personal Identification Number (PIN). This activates your pager so you will know that you have a fax message in the memory.

1 Press **Menu/Set**, **2**, **5**, **1**.

REMOTE FAX OPT
1.FAX FWD/PAGING

2 Press  until the LCD shows
PAGING?.

FAX FWD/PAGING
PAGING?

Press **Menu/Set**.

3 Enter your pager phone number
(up to 20 digits).

PAGING
#: _

Followed by **# #**.

Press **Menu/Set**.

Do not include the area code if it is the same as that of your MFC.
For example, press **1 8 0 0 5 5 1 2 3 4 # #**.

4 If your pager needs a PIN, enter the
PIN, press **#**, press **Redial/Pause**,
enter your fax number followed by **#**
#.

PIN
#: _

Press **Menu/Set**.

(For example, press **1 2 3 4 5 # Redial/Pause 1 8 0 0 5 2 1**
2 8 4 6 # #)

—OR—

If you do not need a PIN, press **Redial/Pause**, enter the fax
number of your MFC followed by **# #**.

Press **Menu/Set**.

(For example, press **Redial/Pause 1 8 0 0 5 2 1 2 8 4 6 # #**)

5 Press **Stop/Exit**.



You cannot change a Paging number or PIN remotely.

Setting your remote access code

The remote access code lets you access the Remote Retrieval features when you are away from your MFC. Before you use the remote access and retrieval features, you have to set up your own code. The default code is inactive code (--- *).

1 Press **Menu/Set, 2, 5, 3**.

REMOTE FAX OPT
3.REMOTE ACCESS

2 Enter a three-digit number from 000 to 999.

Press **Menu/Set**. (The “*” cannot be changed.)



Do not use the same digits that appear in your Fax Receive Code (* 51) or Telephone Answer Code (#51). (See *Operation from extension telephones* on page 5-6.)

3 Press **Stop/Exit**.



You can change your code at any time by entering a new one. If you want to make your code inactive, press **Stop/Exit** in Step 2 to restore the inactive setting (--- *).

Remote retrieval

You can call your MFC from any telephone or fax machine using touch tone, then use the Remote Access Code and remote commands to retrieve fax messages. Cut out the Remote Retrieval Access Card on the last page and keep it in your wallet to help you.

Using your remote access code

- 1** Dial your fax number from a telephone or another fax machine using touch tone.
- 2** When your MFC answers, immediately enter your Remote Access Code (3 digits followed by *).
- 3** The MFC signals if it has received fax messages:
1 long beep — Fax messages
No beeps — No fax messages
- 4** The MFC gives two short beeps, which tells you to enter a command. The MFC will hang up if you wait longer than 30 seconds to enter a command. The MFC will beep three times, if you enter an invalid command.
- 5** Press **90** to reset the MFC when you've finished.
- 6** Hang up.



If your MFC is set to **MANUAL** mode and you want to use the remote retrieval features, you can access your MFC by waiting about 2 minutes after it starts ringing, and then entering the Remote Access Code within 30 seconds.

Remote commands

Follow the commands below to access features when you are away from the MFC. When you call the MFC and enter your Remote Access Code (3 digits followed by *), the system will give two short beeps and you must enter a remote command.

Remote commands	Operation details
95 Change the Fax Forwarding or Paging settings	
1 OFF	If you hear one long beep, the change has been accepted. If you hear three short beeps, you cannot change it because the conditions have not been met (for example, registering a fax forwarding or paging number). You can register your Fax Forwarding number by entering 4. Fax Forwarding number (see page 8-7). Once you have registered the number, the MFC will change to FAX FORWARD: ON mode.
2 Fax Forwarding	
3 Paging	
4 Fax Forwarding number	
6 Fax Storage ON	You can turn FAX STORAGE to ON (or OFF after you have retrieved or erased all your messages).
7 Fax Storage OFF	
96 Retrieve a fax	
2 Retrieve all faxes	Enter the number of a remote fax machine to receive stored fax messages. (See page 8-7.)
3 Erase faxes from the memory	If you hear one long beep, you can erase fax messages from the memory.
97 Check the Receiving Status	
1 Fax	You can check whether your MFC has received any faxes. If it has, you will hear one long beep. If it hasn't, you will hear three short beeps.
98 Change the Receive Mode	
1 EXTERNAL TAD	If you hear one long beep, you can change the Receive Mode.
2 FAX/TEL	
3 FAX ONLY	
90 Exit	After a long beep, you can exit Remote Retrieval.

Retrieving fax messages

- 1 Dial your fax number.
 - 2 When your MFC answers, immediately enter your Remote Access Code (3 digits followed by *). If you hear one long beep, you have messages.
 - 3 As soon as you hear two short beeps, use the dial pad to press **962**.
 - 4 Wait for the long beep, and then use the dial pad to enter the number of the remote fax machine where you want your fax messages sent to followed by **##** (up to 20 digits).
-  You cannot use * and # as dial numbers. However, press # if you want to store a pause.
- 5 Hang up after you hear your MFC beep. Your MFC will call the other machine, which will then print your fax messages.

Changing your Fax Forwarding number

You can change the default setting of your fax forwarding number from another telephone or fax machine using Touch Tone.

- 1 Dial your fax number.
 - 2 When your MFC answers, immediately enter your Remote Access Code (3 digits followed by *). If you hear one long beep, you have messages.
 - 3 When you hear two short beeps, use the dial pad to press **954**.
 - 4 Wait for the long beep, and then use the dial pad to enter the new number of the remote fax machine where you want your fax messages forwarded followed by **##** (up to 20 digits).
-  You cannot use * and # as dial numbers. However, press # if you want to store a pause.
- 5 Hang up after you hear your MFC beep.

9 Printing reports

MFC settings and activity

You need to set up the Transmission Verification Report and Activity Report Interval in the menu table.

Press **Menu/Set, 2, 4, 1.**

—OR—

Press **Menu/Set, 2, 4, 2.**

SETUP REPORTS
1. TRANSMISSION

SETUP REPORTS
2. ACT. INTERVAL

Customizing the Transmission Verification Report

You can use the Transmission Report as proof that you sent a fax. This report lists the time and date of transmission and whether the transmission was successful (OK). If you select **ON** or **ON+IMAGE**, the report will print for every fax you send.



When the feature is **OFF**, the Report will only print if there is a transmission error. (NG).

If you send a lot of faxes to the same place, you may need more than the job numbers to know which faxes you must send again. Selecting **ON+IMAGE** or **OFF+IMAGE** will print a section of the fax's first page on the report to help you remember.

1 Press **Menu/Set, 2, 4, 1.**

2 Press  to select **OFF**, **OFF+IMAGE**, **ON** or **ON+IMAGE**.
Press **Menu/Set**.

3 Press **Stop/Exit**.

SETUP REPORTS
1. TRANSMISSION

Setting the Fax Activity Report Interval

You can set the MFC to print activity reports at specific intervals (every 50 faxes, 6, 12 or 24 hours, 2 or 7 days). If you set the interval to OFF, you can print the report by following the Steps on the next page.

The default setting is EVERY 50 FAXES.

1 Press **Menu/Set, 2, 4, 2.**

SETUP REPORTS 2.ACT. INTERVAL

2 Press  to choose an interval.
Press **Menu/Set.**

ACT. INTERVAL EVERY 50 FAXES

(If you choose 7 days, the LCD will ask you to choose a day on which to begin the 7-day countdown.)

3 Enter the time to begin printing in 24-hour format.
Press **Menu/Set.**

(For example: enter 19:45 for 7:45 PM.)

4 Press **Stop/Exit.**



If you select 6, 12, 24 hours, 2 or 7 days, the MFC will print the report at the selected time and then erase all jobs from its memory. If the MFC's memory becomes full with 200 jobs before the time you selected has passed, the MFC will print the Activity Report early and then erase all jobs from memory. If you want an extra report before it is due to print, you can print it without erasing the jobs from memory.

Printing reports

Five reports are available:

PRINT REPORTS
1.HELP LIST

Prints the Help List so you can see at-a-glance how to quickly program your MFC.

PRINT REPORTS
2.AUTO DIAL

Lists names and numbers stored in the Speed Dial memory, in numerical order.

PRINT REPORTS
3.FAX ACTIVITY

Lists information about the last incoming and outgoing faxes.

(TX means Transmit.) (RX means Receive.)

PRINT REPORTS
4.TRANSMISSION

Prints a Transmission Verification Report for your last transmission.

PRINT REPORTS
5.USER SETTINGS

Lists settings for GENERAL SETUP, SETUP RECEIVE, SETUP SEND, SETUP REPORTS, TEL SERVICE and REMOTE FAX OPT.

To print a report

1 Press **Menu/Set**, **6**.

2 Press  to select the report you want.

Press **Menu/Set**.

—OR—

Enter the number of the report you want to print.

For example, press **1** to print the Help List.

3 Press **Fax Start**.

SELECT ↑ ↓ & SET
6.PRINT REPORTS

10 Making copies

Using the MFC as a copier

Your MFC allows you to make high-quality photocopies and transparencies. Copies can be in black and white or full color. Always make sure you have paper in the paper tray before making copies. Do not pull on the paper while copying is in progress.

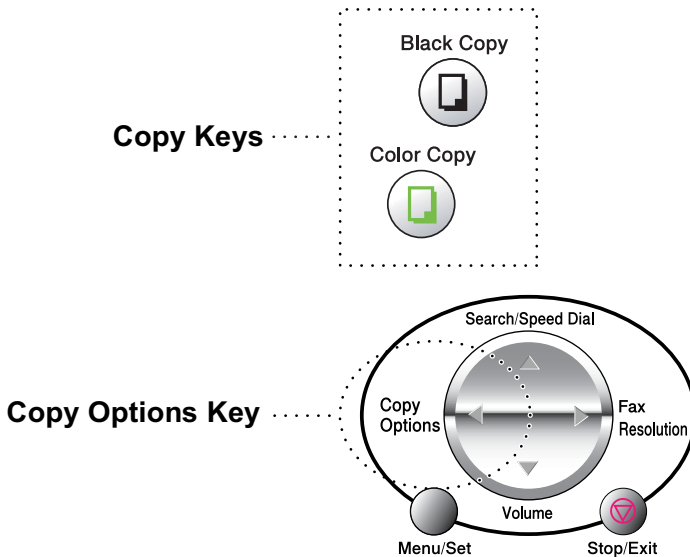

 Incoming faxes cannot be received on paper or into the memory while the MFC is copying.

Single or multiple copies

You can make multiple copies using the scanner glass. Multiple copies will be stacked (all copies of page 1, then all copies of page 2, and so on). Use the **Copy Options** key to choose more settings. (See *Using Copy Options key (Temporary Settings)* on page 10-4.)

- 1 Lift the Document Cover.

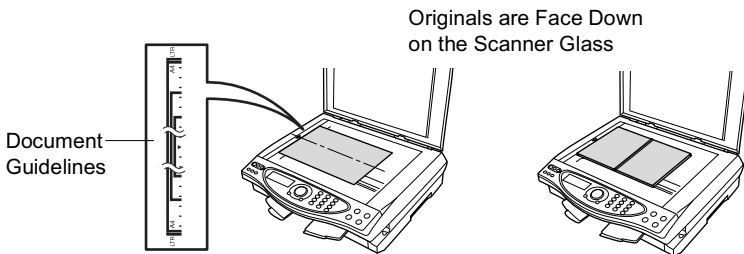

- 2 Using the document guidelines on the left, center the original face down on the scanner glass and close the document cover.
- 3 Using the dial pad, enter the number of copies you want (up to 99).
For example, press **3 8** for 38 copies.
- 4 Press **Black Copy** or **Color Copy**.
The MFC will start scanning the original.

Out of memory message

If the memory becomes full before you are making copies, the LCD will show this message:

OUT OF MEMORY
PLAIN NORMAL

If the OUT OF MEMORY message appears, press **Stop/Exit** to cancel. You will need to clear some jobs from the memory before you can continue.



To gain extra memory, you can turn off Fax Storage.
(See *Setting Fax Storage* on page 8-1.)

—OR—

Print the faxes that are in the memory. (See *Printing a fax from the memory* on page 5-7.)



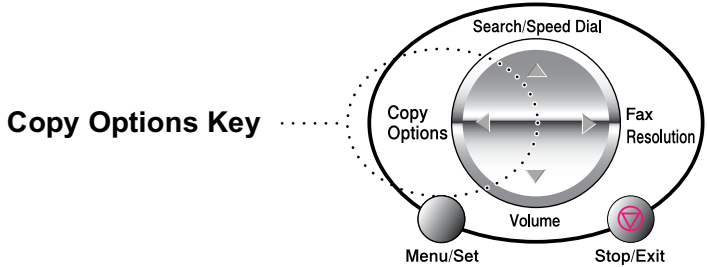

When you get an OUT OF MEMORY message, you may be able to make copies if you first print incoming faxes in the memory to restore the memory to 100%.

Using Copy Options key (Temporary Settings)

When you want to change the settings only for the next copy, use the **Copy Options** key.



You can use different combinations. For example, if you want to copy a photograph on glossy paper with best print quality, press **Copy Options** to select **BEST** in the Quality setting and **GLOSSY** in the Paper Type setting.

Press Copy Options	Menu Selections	Options	Factory Setting	Page
	 +  select Menu/Set	 +  select Menu/Set		
	NO. OF COPIES:01	NO. OF COPIES:01 (01-99)	01	
	QUALITY	FAST/NORMAL/BEST	NORMAL	10-6
	ENLARGE/REDUCE	25%/50%/78%/94% A4→LTR/100%/104% EXE→LTR/150%/200%/400%/ZOOM	100%	10-7
	PAPER TYPE	PLAIN/INK JET/GLOSSY (4-COLOR or 3-COLOR)/TRANSPARENCY	PLAIN	10-8
	PAPER SIZE	LETTER/LEGAL/A4/4" (W)×6" (H)	LETTER	10-9
	BRIGHTNESS	- ■■■■ +	- ■■■□ +	10-9
	PAGE LAYOUT	OFF(1 IN 1)/2 IN 1/4 IN 1/POSTER	OFF(1 IN 1)	10-10

After you finish choosing settings using the **Copy Options** key, the LCD shows:

PRESS COPY OR ↑ ↓ FOR NEXT OPT.

Press  to select more settings.
—OR—

Press **Black Copy** or **Color Copy** if you're finished choosing settings.



These settings are temporary, and the MFC returns to its default settings 60 seconds after it finishes copying. If you want to reuse these temporary settings, you must start copying the next original on the scanner glass before the 60 seconds expire.

No. of Copies

- 1 Place the original face down on the scanner glass.
- 2 Press **Copy Options** and  to select NO. OF COPIES:01.



SELECT ↑ ↓ & SET NO. OF COPIES:01

- 3 Press the number of copies using the dial pad.
Press **Menu/Set**.
- 4 To start copying now, press **Black Copy** or **Color Copy**.
—OR—
Press  for more settings.

Quality

- 1 Place the original face down on the scanner glass.
- 2 Press **Copy Options** and  to select QUALITY.



QUALITY NORMAL

Press **Menu/Set**.
- 3 Press  to select NORMAL, FAST or BEST.
Press **Menu/Set**.
- 4 To start copying now, press **Black Copy** or **Color Copy**.
—OR—
Press  for more settings.



NORMAL	Recommended mode for ordinary printouts. Good copy quality with adequate copy speed.
FAST	Fast copy speed and lowest ink consumption. Use FAST to save time (documents to be proof-read, large documents or many copies).
BEST	Use this mode to copy precise images such as photographs. BEST uses the highest resolution and slowest speed.

Enlarge/Reduce

You can select the following enlargement or reduction ratios.
ZOOM allows you to enter a ratio from 25% to 400%.

<p>Press Copy Options</p>  <p>and</p>  <p>to select ENLARGE/REDUCE</p>	100%
	94% A4 → LTR
	78%
	50%
	25%
	ZOOM
	400%
	200%
	150%
	104% EXE → LTR

- 1 Place the original face down on the scanner glass.
- 2 Press **Copy Options** and  to select **ENLARGE/REDUCE**.
 Press **Menu/Set**.



ENLARGE/REDUCE
 100%
- 3 Press  to select the enlargement or reduction ratio you want.
 Press **Menu/Set**.
 —OR—
 You can select **ZOOM** and press **Menu/Set**.
 Use the dial pad to enter an enlargement or reduction ratio from 25% to 400%.
 Press **Menu/Set**.
 (For example, press **5 3** to enter 53%.)
- 4 Press **Black Copy** or **Color Copy**.
 —OR—
 Press  for more settings.



Special Copy Options (2in1, 4in1 or Poster) are not available with Enlarge/Reduce.

Paper Type

You can change the paper type only for the next copy. Select the type of media that you are using to get the best print quality.

- 1 Place the original face down on the scanner glass.
- 2 Press **Copy Options** and  to select PAPER TYPE.
Press **Menu/Set**.
- 3 Press  to select the type of paper you are using (PLAIN, INKJET, GLOSSY or TRANSPARENCY).
Press **Menu/Set**.
- 4 If you selected GLOSSY, press  to select GLOSSY : 4-COLOR or GLOSSY : 3-COLOR.
Press **Menu/Set**.



The print quality of black ink depends on the type of glossy paper you are using. Black ink is used when you select GLOSSY : 4-COLOR. If the glossy paper you are using repels the black ink, select GLOSSY : 3-COLOR, which simulates black ink by combining the three ink colors.

- 5 Press **Color Copy** (or **Black Copy**).
—OR—
Press  for more settings.





You can change the default Paper Type setting at any time. (See *Setting the Paper Type* on page 4-1.)

Paper Size

You can change the paper size setting only for the next copy.







You can copy only on Letter, Legal, A4 and Post Card (4"X6") paper.

- 1 Place the original face down on the scanner glass.
- 2 Press **Copy Options** and  to select PAPER SIZE.
Press **Menu/Set**.
- 3 Press  to select the size of paper you are using (LETTER, LEGAL, A4 or 4 " (W) × 6 " (H)).
Press **Menu/Set**.
- 4 Press **Black Copy** or **Color Copy**.
—OR—
Press  for more settings.

Brightness

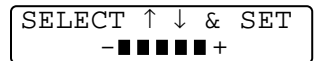

You can adjust the copy brightness to make copies darker or lighter.

- 1 Place the original face down on the scanner glass.
- 2 Press **Copy Options** and  to select BRIGHTNESS.
Press **Menu/Set**.
- 3 Press  to make a lighter copy.
—OR—
Press  to make a darker copy.
Press **Menu/Set**.
- 4 Press **Black Copy** or **Color Copy**.
—OR—
Press  for more settings.



Page Layout

You can save paper by copying either two or four pages onto one page, or you can make a poster size copy.

- 1 Place the original face down on the scanner glass.
- 2 Press **Copy Options** and  to select PAGE LAYOUT.
Press **Menu/Set**.
- 3 Press  to select 2 IN 1, 4 IN 1, POSTER (or OFF (1 IN 1)).
Press **Menu/Set**.
- 4 Press **Black Copy** or **Color Copy**.
The MFC starts scanning the first page.
- 5 If you selected 2 IN 1 or 4 IN 1 in Step 4, put the next original on the scanner glass.
Press **Menu/Set**.
Repeat Step 5 for each page of the layout.
- 6 After all the pages of the original have been scanned, press **Black Copy** or **Color Copy** to end.

NEXT:PRESS SET
END:PRESS COPY



4 in 1

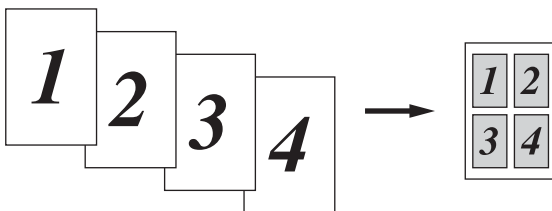

Poster

You can make a poster size copy of a photograph.

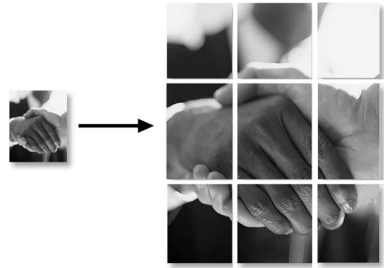

For 2 in 1 or 4 in 1 copies, you cannot change the enlargement or reduction ratio or print on glossy paper.

For color 2 in 1 or 4 in 1 copies, you can use letter and A4 size paper. You cannot make more than one copy.

For POSTER copies, you cannot make more than one copy or use the Enlarge/Reduce setting.

Changing the default copy settings

You can adjust the copy settings that are shown in the chart. These settings will stay until you change them again.



Submenu	Menu Selections	Options	Factory Settings
1.QUALITY	—	NORMAL BEST FAST	NORMAL
2.BRIGHTNESS	—	- ■■■■ + - ■■■□ + - ■■■□ + - ■■■□ + - ■■■□ +	- ■■■□ +
3.CONTRAST	—	- ■■■■ + - ■■■□ + - ■■■□ + - ■■■□ + - ■■■□ +	- ■■■□ +
4.COLOR ADJUST	1.RED	R: - ■■■■ + R: - ■■■□ + R: - ■■■□ + R: - ■■■□ + R: - ■■■□ +	R: - ■■■□ +
	2.GREEN	G: - ■■■■ + G: - ■■■□ + G: - ■■■□ + G: - ■■■□ + G: - ■■■□ +	G: - ■■■□ +
	3.BLUE	B: - ■■■■ + B: - ■■■□ + B: - ■■■□ + B: - ■■■□ + B: - ■■■□ +	B: - ■■■□ +

Copy Quality

- 1 Press **Menu/Set, 3, 1.**
- 2 Press  to select NORMAL, BEST or FAST.
Press **Menu/Set.**
- 3 Press **Stop/Exit.**

COPY
1. QUALITY



Brightness

- 1 Press **Menu/Set, 3, 2.**
- 2 Press  to make a lighter copy.
—OR—
Press  to make a darker copy.
Press **Menu/Set.**
- 3 Press **Stop/Exit.**

COPY
2. BRIGHTNESS

Contrast

You can change the contrast to help an image look sharper and more vivid.



- 1 Press **Menu/Set, 3, 3.**
- 2 Press  to increase the contrast.
—OR—
Press  to decrease the contrast.
Press **Menu/Set.**
- 3 Press **Stop/Exit.**

COPY
3. CONTRAST

Color Adjustment

- 1 Press **Menu/Set, 3, 4.**
- 2 Press  to select RED, GREEN or BLUE.

COPY 4.COLOR ADJUST

- 3 Press  to increase the color saturation.
—OR—
Press  to decrease the color saturation.
Press **Menu/Set.**
- 4 Return to Step 2 to select the next color.
—OR—
Press **Stop/Exit.**

Legal limitations

Color reproductions of certain documents are illegal and may result in either criminal or civil liability. This memorandum is intended to be a guide rather than a complete listing of every possible prohibition. In case of doubt, we suggest that you check with counsel as to any particular questionable documents.

The following documents issued by the United States/Canadian Government or any of its Agencies may not be copied:

- Paper money
- Bonds or other certificates of indebtedness
- Certificates of Deposit
- Internal Revenue Stamps (canceled or uncanceled)
- Selective Service or draft papers
- Passports
- United States/Canadian Postage Stamps (canceled or uncanceled)
- Food Stamps
- Immigration Papers
- Checks or drafts drawn by Governmental agencies
- Identifying badges or insignias

Copyrighted works cannot be copied. Sections of a copyrighted work can be copied for 'fair use.' Multiple copies would indicate improper use.

Works of art should be considered the equivalent of copyrighted works.

Licenses and Certificates of Title to motor vehicles may not be copied under certain state/provincial laws.

11 Walk-Up PhotoCapture Center™

Introduction

Your Brother MFC includes three media drives (slots) to use with popular digital camera media: CompactFlash®, SmartMedia®, and Memory Stick®.



CompactFlash®



SmartMedia®



Memory Stick®

The PhotoCapture Center™ feature lets you print digital photos from your digital camera at high resolution to get photo quality printing.

PhotoCapture Center™ requirements

To avoid error conditions, please remember:

- The DPOF file on the media card must be in a valid format.
- The image file extension must be .JPG (Other image file extensions .JPEG, .TIF, .GIF and so on will not be recognized).
- Walk-up PhotoCapture Center™ printing must be performed separately from PhotoCapture Center™ operations using the PC. (Simultaneous operation is not available.)
- IBM Microdrive™ is not compatible with the MFC.
- The MFC can read up to 999 files in a media card.
- Use only Smart media cards with a 3.3 voltage.



When printing the INDEX or IMAGE, the PhotoCapture Center™ will print all the valid images, even if one or more images have been corrupted. A portion of the corrupted image may be printed.

Basic flow

- 1** Insert the media card firmly into the media drive (slot).
(See *Getting started* on page 11-3.)
- 2** Print the index (Thumbnails) of all the images on your media card by selecting **PRINT INDEX**. The images will be numbered.
(See *Printing the Index (Thumbnails)* on page 11-5.)
- 3** To print the images, select **PRINT IMAGES**.
(See *Printing images* on page 11-6.)

You can change the settings for printing images, such as the number of Copies, Paper Type, Paper & Print Size, Print Quality, Brightness and True2Life® by selecting **CHANGE SETTINGS**.

(See *Changing the settings for printing images* on page 11-7.)

Getting started

 There are separate slots on your MFC, for a CompactFlash[®] card, a SmartMedia[®] card and a Memory Stick[®].
Use only Smart media cards with a 3.3 voltage.

The left slot is for a CompactFlash[®] Card, the middle slot is for a Memory Stick[®] and the right is for a SmartMedia[®] Card.
Firmly insert the card into the appropriate slot.

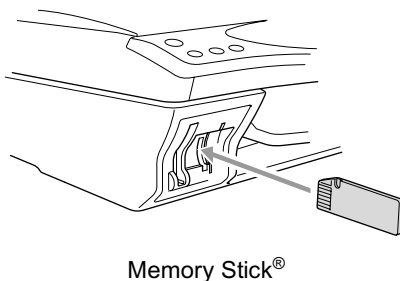
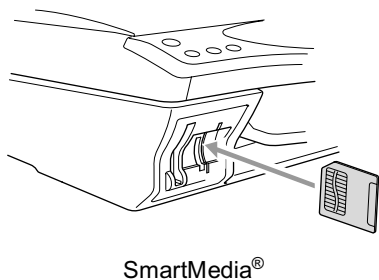
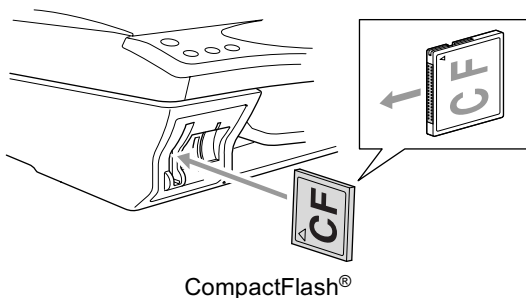

Media Card Indicator Lights:

- **LED** light is ON, the media card is inserted properly.
- **LED** is OFF, the media card is not properly inserted.
- **LED** is BLINKING, the media card is being read or written to.

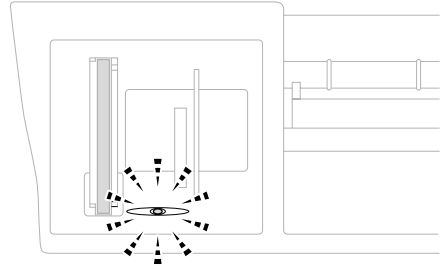

⚠ Do NOT turn off or unplug the power cord or remove the media card from the media drive (slot) while the MFC is reading or writing to the card (LED is blinking). **You will loose your data or damage the card.**

The MFC can only read one Media card at a time so do not insert more than one card. The settings that you want to use with the card will be kept until you take out the media card from the drive (slot), print images or press **Stop/Exit**.

- 1 Insert the media card firmly into the media drive (slot).
- 2 When you insert your media card into the proper slot, the LCD shows.

C.FLASH ACTIVE
Press PhotoCapture key -----



The media active message will be shown for 60 seconds and then the display will return to standby mode (date and time). Even in that case, you can enter the PhotoCapture mode by pressing **PhotoCapture**.

- 3 Press **PhotoCapture**.

The LCD scrolls:

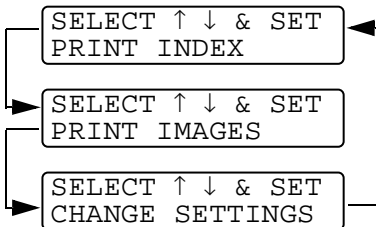

(See *Printing the Index (Thumbnails)* on page 11-5.)

(See *Printing images* on page 11-6.)

(See *Changing the settings for printing images* on page 11-7.)

Printing the Index (Thumbnails)

The PhotoCapture Center™ assigns numbers for images (such as No.1, No.2, No.3, and so on).



→ No.1
DEI.JPG

01.01.2003
100KB

It does not recognize any other numbers or file names that your digital camera or PC have used to identify the pictures. You can print a thumbnail page (Index page with 6 or 4 images per line). This will show all the pictures on the media card.

1 Make sure you inserted the media card.
Press **PhotoCapture**. (See page 11-3.)

2 Press  to select
PRINT INDEX.
Press **Menu/Set**.

SELECT ↑ ↓ & SET
PRINT INDEX

3 Press  to select
6 IMAGES/LINE? or
4 IMAGES/LINE?.
Press **Menu/Set**.

PRINT INDEX
6 IMAGES/LINE?



Index

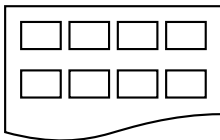

4 Images/line

Index

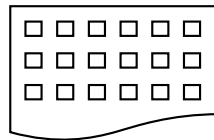

6 Images/line

4 Press **Color Copy** to start printing.



Print time for 4 Images/line will be slower than 6 Images/line, but the quality is better. To print an image, see the next page.

Printing images

Before you can print an individual image, you have to know the image number.



Print the Index first.

(See *Printing the Index (Thumbnails)* on page 11-5.)

1 Make sure you inserted the media card.
Press **PhotoCapture**. (See page 11-3.)

2 Press  to choose
PRINT IMAGES.
Press **Menu/Set**.

SELECT ↑ ↓ & SET
PRINT IMAGES

3 Use the dial pad to enter the image
number that you want to be printed
from the Index page (Thumbnails).
Press **Menu/Set**.

ENTER & SET KEY
IMG:1,3,6

Repeat this step until you have entered all the image numbers
that you want to print.





You can enter all the numbers at one time by using the * key for
a comma or the # key for hyphen.

(For example, Enter **1 * 3 * 6** - to print images No.1, No.3 and
No.6. Enter **1#5** to print images No.1 to No.5).

4 After you have selected all the
image numbers.
Press **Menu/Set** twice.
The LCD shows:

PRESS COLOR COPY
OR ↑ ↓ FOR OPTION

5 To print, press **Color Copy**.
—OR—

To change settings, press  the LCD scrolls through the
settings again. You can select these options by pressing 
and **Menu/Set**.

(See *Changing the settings for printing images* on page 11-7.)

Changing the settings for printing images

You can change the settings for the number of Copies, Paper Type, Paper & Print Size, Print Quality, Brightness and True2Life® only for the next printed image.



Menu Selections	Options (1)	Options (2)	Factory Setting	Page
NO. OF COPIES XX	—	01-99	01	11-8
PAPER TYPE	PLAIN	—	PLAIN	11-8
	INK JET			
	GLOSSY	GLOSSY: 4-COLOR GLOSSY: 3-COLOR		
	TRANSPARENCY	—		
PAPER&PRINT SIZE	LETTER LEGAL A4	PRINT SIZE 5"×3.5", 6"×4", 7"×5", 8"×10"	6"×4"	11-9
	4" (W) X6" (H)	ORIENTATION PORTRAIT LANDSCAPE	LANDSCAPE	
PRINT QUALITY	NORMAL	—	FINE	11-9
	FINE			
	PHOTO			
BRIGHTNESS	- ■■■■ +	—	- ■■■■ +	11-12
	- ■■■□ +			
	- ■■■□ +			
	- ■■■□ +			
	- ■■■□ +			
TRUE2LIFE	ON	—	OFF	11-13
	OFF			

Menu selections





Make sure you have entered the image number that you want to be printed. (See page 11-6.)

Number of Copies

- 6 Press  to select NO. OF COPIES: 01.
Press **Menu/Set**.
- 7 Use the dial pad to enter the number of copies you want.
Press **Menu/Set**.
- 8 Press **Color Copy** to print.
—OR—
Press  for more settings.

Paper Type

- 6 Press  to select PAPER TYPE.
Press **Menu/Set**.
- 7 Press  to select the type of paper you are using, (PLAIN, INK JET, GLOSSY or TRANSPARENCY).
Press **Menu/Set**.
- 8 If you selected GLOSSY, press  to select GLOSSY: 4-COLOR or GLOSSY: 3-COLOR.
Press **Menu/Set**.







The print quality of black ink depends on the type of glossy paper you are using. Black ink is used when you select 4-COLOR.

If the glossy paper you are using repels the black ink, select 3-COLOR, which simulates black ink by combining the three ink colors.



- 9 Press **Color Copy** to print.
—OR—
Press  for more settings.

Paper and Print Size

 Make sure you have done Steps 1 to 5 on page 11-6.

- 6 Press  to select PAPER&PRINT SIZE.
Press **Menu/Set**.
- 7 Press  to select the size of the paper you are using (LETTER, LEGAL, A4 or 4" (W) X6" (H)).
Press **Menu/Set**.
- 8 If you select LETTER, LEGAL or A4, press  to select the print size (5"X 3.5", 6"X 4", 7"X 5" or 8"X 10").
Press **Menu/Set**, and go to Step 12.

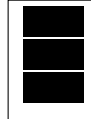
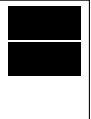
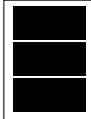
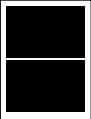
Printed Position

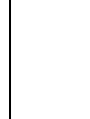
① 5"X 3.5"*1	② 6"X 4"	③ 7"X 5"	④ 8"X 10"
  <p>Letter A4/Legal</p>	  <p>Letter/A4 Legal</p>	 	 

*1 The printed position for 5" X 3.5" are different depending on the paper size you are using.

—OR—

If you selected 4" (W) X6" (H), go to Step 9.

- 9 Load the post card with the top edge down and print side is towards you.

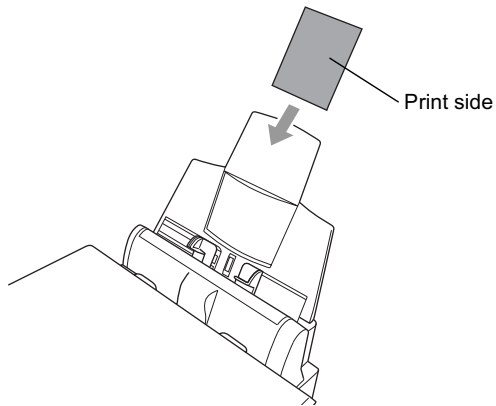

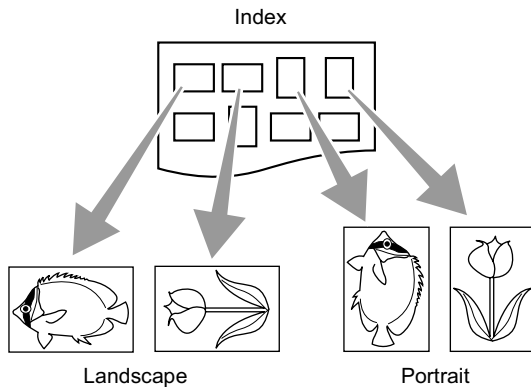

- 10 Check the printed thumbnail image on the index sheet.



 Some image taken by some cameras have the orientation information.

11 Press  to select LANDSCAPE or PORTRAIT.
Press **Menu/Set**.

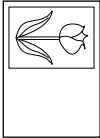
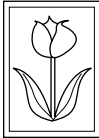
The result of the output (4 " (W) X 6 " (H)

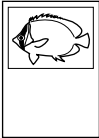

	LANDSCAPE	PORTRAIT
Portrait Image 		
Landscape Image 		

12 Press **Color Copy** to print.

—OR—

Press  for more settings.

Print Quality





- 6** Press  to select PRINT QUALITY.
Press **Menu/Set**.
- 7** Press  to select NORMAL, FINE or PHOTO.
Press **Menu/Set**.

NORMAL	Recommended mode for ordinary printouts. Good print quality with adequate print speed.
FINE	Better print quality than normal and faster copy speed than PHOTO.
PHOTO	Use this mode to print precise images such as photographs. PHOTO uses the highest resolution and slowest speed.

- 8** Press **Color Copy** to print.
—OR—
Press  for more settings.

Brightness

 Make sure you have done Steps 1 to 5 on page 11-6.

- 6** Press  to select BRIGHTNESS.
Press **Menu/Set**.
- 7** Press  to make a lighter print.
—OR—
Press  to make a darker print.
Press **Menu/Set**.
- 8** Press **Color Copy** to print.
—OR—
Press  for more settings.

Color enhancement (True2Life®)

You can turn on the color enhancement (True2Life®) feature to print more vivid images.

If you want to customize the White Balance, Sharpness or Color Density, press **Menu/Set, 4, 5**. (See *Color enhancement (True2Life®)* on page 11-17.)

6 Press  to select TRUE2LIFE.
Press **Menu/Set**.

7 Press  to select ON (or OFF).
Press **Menu/Set**.

8 Press **Color Copy** to print.
—OR—
Press  for more settings.



- The PhotoCapture Center™ prints only in color. Black & White printing and Enlargement/Reduction is not available when using this feature.
- The PhotoCapture Center™ returns to its default setting when you take out the media card, print images or press **Stop/Exit**.

DPOF printing

DPOF stands for Digital Print Order Format.

Major Digital Camera manufacturers (Canon Inc., Eastman Kodak Company, Fuji Photo Film Co. Ltd. and Matsushita Electric Industrial Co., Ltd. and Sony Corporation.) created this standard to make it easier to print images from a digital camera.

If your digital camera supports DPOF printing, you will be able to select on the Digital Camera display the images and number of copies you want to print.

When the memory card (CompactFlash®, SmartMedia® or Memory Stick®) with DPOF information is put into your MFC, you can print the selected image easily.

- 1 Insert your media card into the proper drive (slot).

C.FLASH ACTIVE
Press PhotoCapture key -----



The media active message will be shown for 60 seconds and then the display will return to standby mode (date and time). Even in that case, you can enter the PhotoCapture mode by pressing **PhotoCapture**.

- 2 Press **PhotoCapture**.

- 3 Press  to select PRINT IMAGES to select individual images. Press **Menu/Set**.

- 4 If there is a DPOF file on the card, the LCD shows:

DPOF PRINT
1.YES 2.NO

- 5 Press **1** to select 1.YES.
Press **Color Copy**.

PRESS COLOR COPY
OR ↑ ↓ FOR OPTION



If you want to print an Index (thumbnails) or choose the images and their print options now, select 2.NO.

- 6 Press **Color Copy** to print.

—OR—

Press  to change the settings for the number of Copies, Paper Type, Paper & Print Size, Print Quality, Brightness or True2Life®.

(See *Changing the settings for printing images* on page 11-7.)

Changing the default settings

You can adjust the Print Quality, Print Size, Brightness, Contrast, True2Life® and Scan to Card settings, that are shown in the chart. These settings will remain set until you change them again.

Press **Menu/Set, 4**, followed by the number of the setting you want to change. (See details on the following pages.)

Submenu	Menu Selections	Options (1)	Options (2)	Factory Settings
1.PRINT QUALITY	—	NORMAL FINE PHOTO	—	FINE
2.PRINT SIZE	—	5"×3.5" 6"×4" 7"×5" 8"×10"	—	6"×4"
3.BRIGHTNESS	—	- ■■■■■ + - ■■■■ □ + - ■■■ □ □ + - ■■■ □ □ □ + - ■ □ □ □ □ +	—	- ■■■ □ □ +
4.CONTRAST	—	- ■■■■■ + - ■■■■ □ + - ■■■ □ □ + - ■ □ □ □ □ + - □ □ □ □ □ +	—	- ■■■ □ □ +
5.TRUE2LIFE	ON	1.WHITE BALANCE	- ■■■■■ + - ■■■■ □ + - ■■■ □ □ + - ■ □ □ □ □ + - □ □ □ □ □ +	(- ■■■ □ □ +)
		2.SHARPNESS	- ■■■■■ + - ■■■■ □ + - ■■■ □ □ + - ■ □ □ □ □ + - □ □ □ □ □ +	(- ■■■ □ □ +)
		3.COLOR DENSITY	- ■■■■■ + - ■■■■ □ + - ■■■ □ □ + - ■ □ □ □ □ + - □ □ □ □ □ +	(- ■■■ □ □ +)
	OFF	—	—	OFF
6.SCAN TO CARD (See <i>How to scan using Windows®</i> on page 14-1.)	—	PDF JPEG	—	PDF

Print Quality

- 1 Press **Menu/Set, 4, 1.**
- 2 Press  to select NORMAL, FINE or PHOTO.
Press **Menu/Set.**
- 3 Press **Stop/Exit.**



PHOTOCAPTURE
1.PRINT QUALITY

Print Size

- 1 Press **Menu/Set, 4, 2.**
- 2 Press  to select 5"×3.5", 6"×4", 7"×5" or 8"×10".
Press **Menu/Set.**
- 3 Press **Stop/Exit.**

PHOTOCAPTURE
2.PRINT SIZE



Brightness

- 1 Press **Menu/Set, 4, 3.**
- 2 Press  to select BRIGHTNESS.
Press **Menu/Set.**
- 3 Press  to make a lighter print.
—OR—
Press  to make a darker print.
Press **Menu/Set.**
- 4 Press **Stop/Exit.**

PHOTOCAPTURE
3.BRIGHTNESS



Contrast

You can choose the contrast setting. More Contrast will make an image look sharper and more vivid.

- 1 Press **Menu/Set, 4, 4.**
- 2 Press  to select CONTRAST.
Press **Menu/Set.**
- 3 Press  to increase the contrast.
—OR—
Press  to decrease the contrast.
Press **Menu/Set.**
- 4 Press **Stop/Exit.**

PHOTOCAPTURE
4.CONTRAST



Color enhancement (True2Life®)

- 1 Press **Menu/Set**, 4, 5.
- 2 Press  to select TRUE2LIFE.
Press **Menu/Set**.
- 3 Press  to select ON (or OFF).
Press **Menu/Set**.

PHOTOCAPTURE
5.TRUE2LIFE



If you select ON, you can customize the White Balance, Sharpness or Color Density.

- 4 If you selected ON,
Press  to select WHITE BALANCE.
Press **Menu/Set**.
—OR—
To skip the White Balance.
Press  to select SHARPNESS or COLOR DENSITY.
- 5 Press  to adjust the degree of White Balance.
Press **Menu/Set**.
- 6 Repeat Step 4 and Step 5 to adjust the degree of Sharpness and Color Density.
—OR—
Press **Stop/Exit**.

■ White Balance

This setting adjusts the hue of the white areas of an image. Lighting, Camera settings and other influences will effect the appearance of white. The white areas of a picture may be slightly pink, yellow or some other color. By using this adjustment you can correct this effect and bring the white areas back to pure white.

■ Sharpness

This setting enhances the detail of an image. It is similar to adjusting the fine focus on a camera. If the image is not in true focus and you cannot see the fine details of the picture, then adjust the sharpness.

■ Color Density

This setting adjusts the total amount of color in the image. You can increase or decrease the amount of color in an image to improve a washed out or weak picture.

Understanding the Error Messages

Once you are familiar with the types of errors that can occur while you're using the PhotoCapture Center™, you can easily identify and troubleshoot any difficulties.

When an error message appears on the LCD, the MFC will beep to get your attention.

MEDIA ERROR—This message will appear if you insert a media card that is either bad or not formatted, or when there is a problem with the media drive. To clear this error, take out the media card.

NO FILE—This message will appear if you try to access the media card in the drive (slot) does not contain a .JPG file.

OUT OF MEMORY—This message will appear if you are working with images that are too large for the MFC's memory.

Using PhotoCapture Center™ from your PC

You can access the media card that is in the media drive (slot) of the MFC from your PC.

See Using PhotoCapture Center™ from your PC. (See *Using the PhotoCapture Center™ from your PC* on page 19-1 and *Using the PhotoCapture Center™ from a Macintosh®* on page 20-21.)

Using PhotoCapture Center™ for scanning originals

You can scan the originals into a media card. (See *Scan to Card* on page 14-18.)

12 Using the MFC as a printer

Using the Brother MFC-4420C printer driver

A Printer Driver is software that translates data from the format used by a computer into the format required by a particular printer, using a printer command language or page description language.

The printer drivers are on the CD-ROM we have supplied. Install the drivers first by following the Quick Setup Guide. Also, the latest printer driver can be downloaded from the Brother Solutions Center at:

<http://solutions.brother.com>

Features

This MFC offers many features you'll find in a high quality ink jet printer.

Fast Printing Speed—Using Fast mode, you can print up to 11 pages per minute in full color, and up to 13 pages per minute in black.

Brilliant High Quality Output—Printing at 2400 x 1200 dpi resolution on glossy paper gives you highest resolution output.

Beautiful Elaborate Output—You can use 2 in 1, Watermark printing, True2Life[®] technology and other features to get high quality printouts.

Low Running Cost—Whenever you run out of a particular color ink, you will only have to replace the cartridge that's empty.

USB—Universal Serial Bus Interface provides fast communication with your computer.

Straight Paper Path—The MFC can print on many types of paper. Plain paper, inkjet paper, glossy paper, transparencies and envelopes. Use the appropriate type of paper to avoid paper jams.

For complete information about what kinds of paper to use with the MFC, please See *Paper* on page 2-1.

Choosing the right type of paper

To get high quality printing using your MFC, it's very important to select the right type of paper. Be sure to read Chapter 2 Paper in this Guide before you select and purchase paper for the MFC.

How to print your document

When the MFC receives data from your computer, it begins printing by picking up paper from the paper tray. The paper tray can feed many types of paper and envelopes.

- 1** From your computer select the Print command.
If your computer is also connected to any other printers, select **Brother MFC-4420C USB Printer** as your printer driver from the Print or Print Settings menu in your software application, and then click on OK to begin printing.
- 2** Your computer sends a print command and data to the MFC.
The LCD shows `RECEIVING DATA`.
- 3** When the MFC finishes printing all the data, the LCD shows the date and time.



You can select the paper size, and orientation in your application software.

If your application software does not support your custom paper size, select the next larger paper size.

Then adjust the print area by changing the right and left margins in your application software.

Simultaneous printing and faxing

Your MFC can print from your computer while sending or receiving a fax, or while scanning a document into the computer. Fax sending will not be stopped during PC printing.

Clearing data from the memory

If the LCD shows `DATA REMAINS`, you can clear the data that is left in the printer memory by pressing **Stop/Exit**.

Checking the Print Quality

If you want to check the print quality and find out how to improve it, See *How to improve print quality* on page 22-9.

13 Printer driver settings

(Windows® Only)

Printer driver settings

You can change the following printer settings when you print from your computer:

- **Media Type/Quality** (Speed)
- **Page Layout**
- **Near Edge Print**
- **Color Matching/Halftone**
- **Color Enhancement (True2Life®)**
- **Scaling**
- **Watermark**
- **Print Date & Time**
- **Quick Print Setup**

How to access the printer driver settings

- 1 Select **Print** from the **File** menu in your application software.
- 2 Select **Brother MFC-4420C USB Printer** as your printer and click **Properties**. The **Brother MFC-4420C USB Printer** dialog box will appear.



The way you access the printer driver settings depends on your operating system and software applications.



The screens shown in this section are from Windows® 98 Second Edition. The screens on your Computer may vary depending on your Windows Operating System.

Basic tab

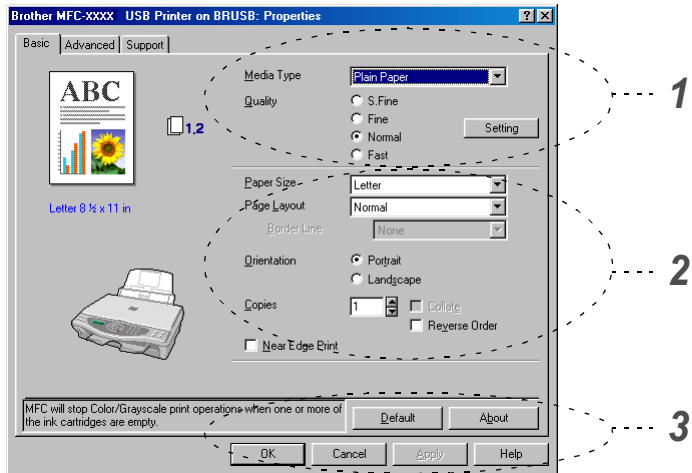

- 1 Select the **Media Type** and **Quality**.
- 2 Select the **Paper Size**, **Page Layout**, **Border Line** (if any), **Orientation**, number of **Copies**, the page order and **Near Edge Print**.
- 3 Click the **Apply** button to apply your selected settings. To return to the default settings, click the **Default** button, then click the **Apply** button.



* This area shows the current settings of **Quality**, **Paper Size**, **Page Layout**, **Orientation**, **Collate/Reverse Order**, **Near Edge Print** and **Color/Grayscale**.

Media Type

To achieve the best print results, the media being printed on should be selected in the driver. The MFC changes the way it prints, depending on the selected media type.

Plain Paper

Inkjet Paper

Glossy Paper (4 color)

Glossy Paper (3 color)

Transparencies



The print quality of black ink depends on the type of glossy paper you are using. Black ink is used when you select *Glossy Paper (4 color)*. If the glossy paper you are using repels the black ink, select *Glossy Paper (3 color)*, which simulates black ink by combining the three ink colors.

Quality

The quality selection allows you to choose the print resolution you want for your document. Print quality and speed are related. The higher the quality the longer it will take to print the document. The quality selections that are available will vary depending on the media type you select.

- **Photo:** 2400 x 1200 dpi. Use this mode to print precise images such as photographs. This is the highest resolution and slowest speed.
- **S.Fine** (Super Fine): 1200 x 1200 dpi. Use this mode to print precise text and photographs. Since the print data is much larger than normal mode, the processing time, data transfer time and print time will be longer.
- **Fine:** 600 x 600 dpi. Better print quality than **Normal** mode and faster print speed than **Super Fine**.
- **Normal:** 600 x 300 dpi. Good print quality with typical print speed.
- **Fast:** 600 x 150 dpi. The fastest print mode and the lowest ink consumption. Use this mode to print large volume documents or a document for proofing.

Media Type	Color/Grayscale	Print Quality Selection
Plain Paper	Color/Grayscale	Fast, Normal , Fine, S.Fine
Inkjet Paper	Color	Fine , S.Fine, Photo
	Grayscale	Fine, S.Fine , Photo
Glossy Paper (4 or 3 color)	Color	S.Fine, Photo
	Grayscale	S.Fine , Photo
Transparencies	Color/Grayscale	Fine , S.Fine



The factory settings are shown in bold.

Bi-Directional Printing

When **Bi-Directional Printing** is selected, the print heads print in both directions and offer faster print speeds. When not selected, the print heads will only print in one direction to provide higher quality printouts.

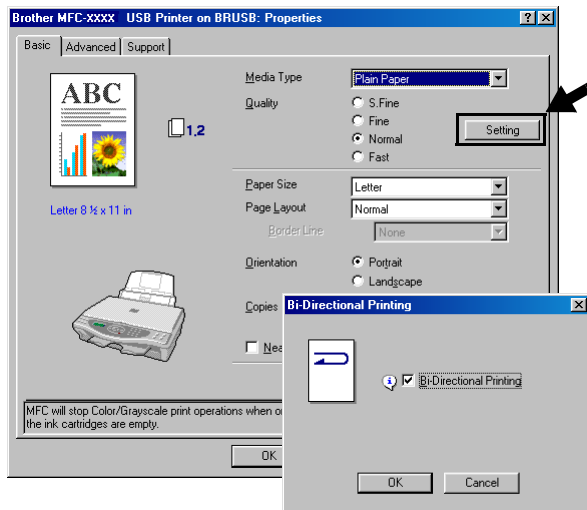

Paper Size

The **Paper Size** selection provides a large selection of standard paper sizes. If you wish, you can create a custom size ranging from 3.5" x 5" (89 x 127 mm) to 8.5" x 14" (216 x 355.6 mm). From the drop-down box, select the **Paper Size** you are using.



You can enter custom size by selecting *User Defined*. Select the proper paper thickness to improve the quality of your output.

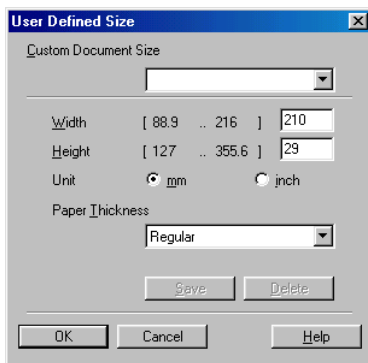

Page Layout

The **Page Layout** selection can reduce the image size of a page allowing multiple pages to be printed on one sheet of paper or enlarging the image size for printing one page on multiple sheets of paper. If you are using Windows® 98/98SE/Me, the 4 in 1 layout is not available.

Border Line

When printing multiple pages on one sheet with the **Page Layout** feature, you can choose to have a solid border, dashed border or no border around each page on the sheet.

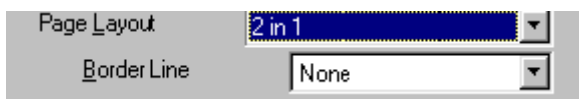

Orientation

Orientation selects the position of how your document will be printed (**Portrait** or **Landscape**).

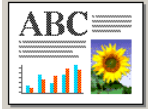

Portrait (Vertical)	Landscape (Horizontal)
 A document page oriented vertically. It contains the text "ABC", a bar chart, and a sunflower image.	 A document page oriented horizontally. It contains the text "ABC", a bar chart, and a sunflower image.

Copies

The **Copies** selection sets the number of copies that will be printed (1 to 999).

Collate

With the **Collate** check box selected, one complete copy of your document will be printed and then repeated for the number of copies you selected. If the **Collate** check box is not selected, then each page will be printed for all the copies selected before the next page of the document is printed.

Reverse Order

Reverse Order prints the pages of your document in the opposite order.

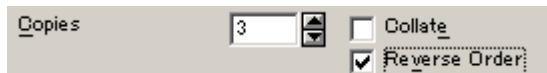

Near Edge Print

Near Edge Print feature expands the printable area at the bottom edge of the paper up to 0.02 inch (0.5 mm). Print time will be slightly slower. Available for **Letter, A4, Postcard and Index Card paper**.

Not available for transparencies.



Advanced tab

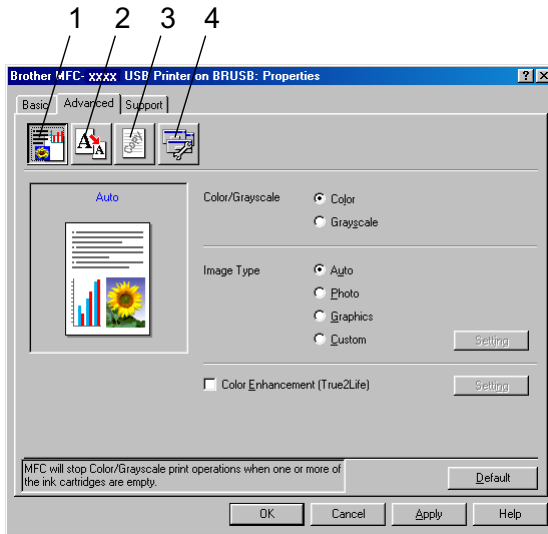

To return to the default settings, click the **Default** button.

Change the tab settings by selecting one of the following icons:

1. Color
2. Scaling
3. Watermark
4. Device Options

Color

Color/Grayscale

This selection allows a color document to be printed in black and white using gray scale.

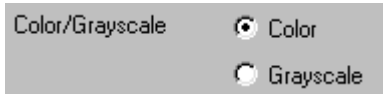
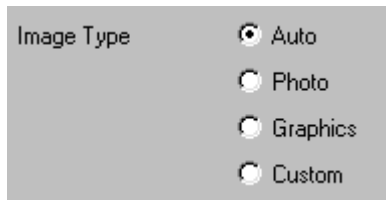

Image Type

The printer driver will select the most suitable color matching and half tone method, depending on your image type. Generally, text and business graphics are printed vividly and photographic images are printed softly.

- **Auto:** The printer driver automatically selects the image type.
- **Photo:** Select this mode for photographic images.
- **Graphics:** Select this mode for documents that contain text or business graphics (charts or clip art).
- **Custom:** If you want to select the color matching and halftone method, manually select this mode.



Custom Image Type

You can select the color matching method manually. Select the best one for your document.

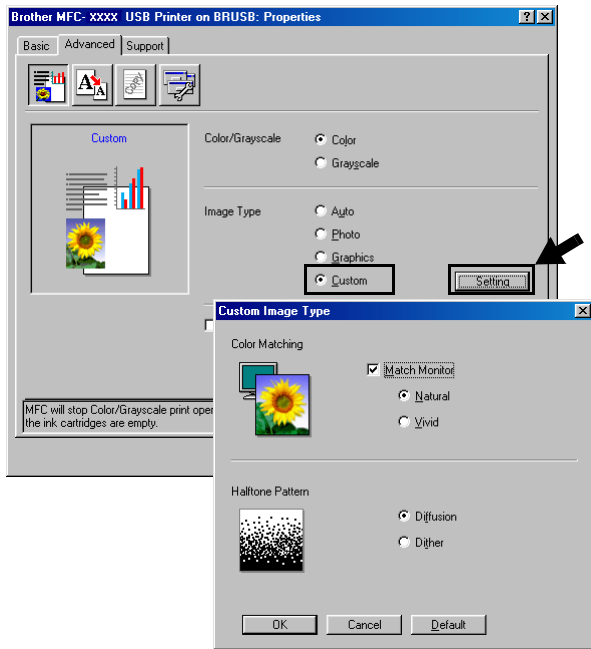

Match Monitor

Color is adjusted to get the closest color match to the PC monitor.

- **Natural:** Suitable for photographic images. The color is adjusted to print a more natural color.
- **Vivid:** Suitable for business graphics such as charts, graphics and text. The color is adjusted to give more vivid color.

Halftone Pattern

The MFC can use two methods (**Diffusion** or **Dither**) to arrange where to place dots to express halftones. There are some predefined patterns set for this and you can select which one to use for your document. Select the appropriate method.

- **Diffusion:** Dots are placed at random to create the halftones. This method of printing is more suitable for printing photographs that have delicate shades and graphics.
- **Dither:** Dots are arranged in a pre-defined pattern to make halftones. This type of printing is more suitable to printing graphics that have definite color boundaries or for printing charts such as business charts.



Some halftone settings cannot be selected with certain combinations of **Media Type** and **Quality** selections.

Color Enhancement (True2Life®)

Selecting **Color Enhancement (True2Life®)** enables the **True2Life®** feature. This feature analyzes your image to improve quality sharpness, white balance and color density. This process may take several minutes depending on the size of the image and the specifications of your computer.

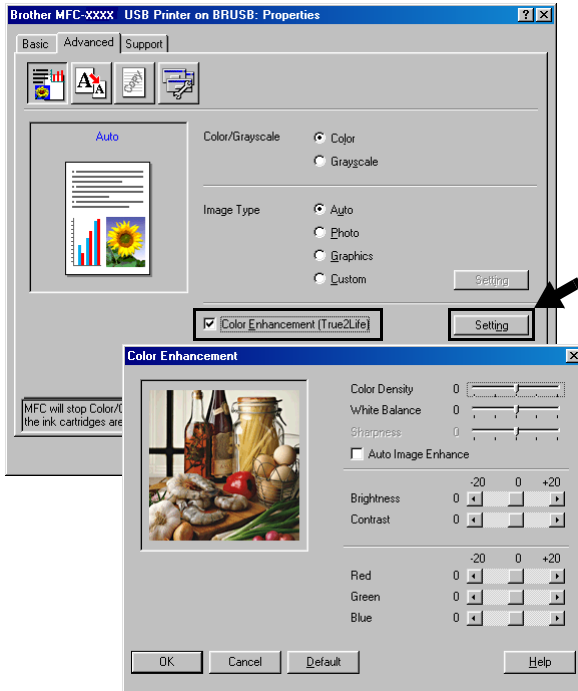

■ Color Density

This setting adjusts the total amount of color in the image. You can increase or decrease the amount of color in an image to improve a washed out or weak picture.

■ White Balance

This setting adjusts the hue of the white areas of an image. Lighting, camera settings and other influences will effect the appearance of white. The white areas of a picture may be slightly pink, yellow or some other color. By using this adjustment you can correct this effect and bring the white areas back to pure white.

■ **Sharpness**

This setting enhances the detail of an image. It is similar to adjusting the fine focus on a camera. If the image is not in true focus and you can not see the fine details of the picture, then adjust the sharpness.

■ **Auto Image Enhance**

Auto Image Enhance allows individual adjustment of picture settings to improve the printed image and analyzes data from surrounding or neighboring pixels in the original.

■ **Brightness**

This setting adjusts the brightness of the whole image. To lighten or darken the image move the scroll bar to the left or right.

■ **Contrast**

This setting adjusts the contrast of an image. This will make darker areas darker and lighter areas lighter. Increase the contrast when you want an image to be clearer. Decrease the contrast when you want an image to be more subdued.

■ **Red**

Increases the intensity of the **Red** color to make the image redder.

■ **Green**

Increase the intensity of the **Green** color to make the image greener.

■ **Blue**

Increase the intensity of the **Blue** color to make the image bluer.

Scaling

You can change the print size of your document with the **Scaling** feature.

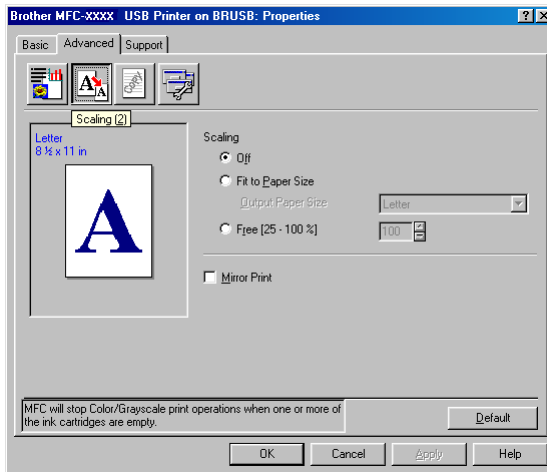

- Check **Off** if you want to print the document as it appears on your screen.
- Check **Fit to Paper Size**, if your document has an unusual size, or if you have only the standard size paper.
- Check **Free** if you want to reduce the size.
- Check **Mirror Print** to reverse the data from left to right.

Watermark

You can place a logo or text into your document as a Watermark. You can select one of the preset Watermarks, or you can use a bitmap file or text file that you have created.

Check **Use Watermark**, and then select the watermark you want to use.

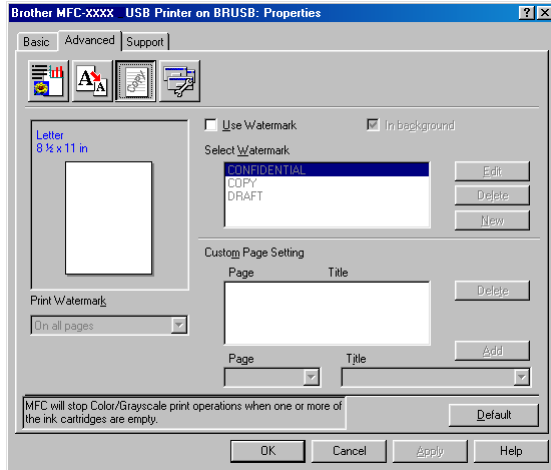

In background

Check **In background** with the Watermark to print the watermark image in the background of your document. If this feature is not checked then the Watermark will be printed on top of your document.

In Outline Text (Window® 2000 Professional/XP Only)

Check **In Outline Text** if you only want to print an outline of the watermark.

Print Watermark

The **Print Watermark** feature offers the following print choices:

- *On all pages*
- *On first page only*
- *From second page*
- *Custom*

Watermark Style

You can change the Watermark's size and position on the page by selecting the Watermark, and clicking the **Edit** button. If you want to add a new Watermark, click the **New** button, and then select **Text** or **Bitmap** in the **Watermark Style**.

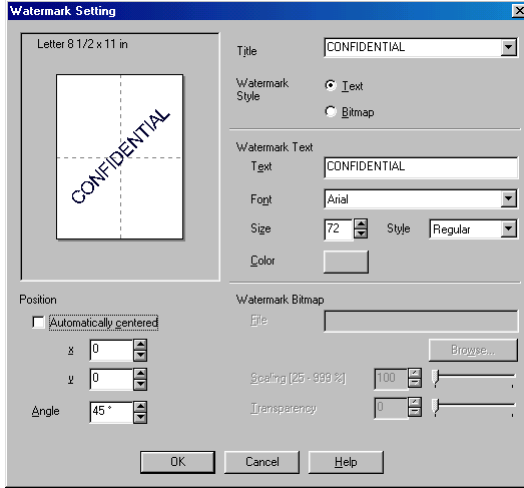

■ Watermark Text

Enter your Watermark text into the **Text** Box, and then select the **Font**, **Size**, **Color** and **Style**.

■ Watermark Bitmap

Enter the file name and location of your bitmap image in the **File** box, or **Browse** for the file location. You can also set the scaling size of the image.

■ Position

This setting offers you the control for where the Watermark is to be positioned on the page.

Device Options

Lets you set the following Printer Functions:

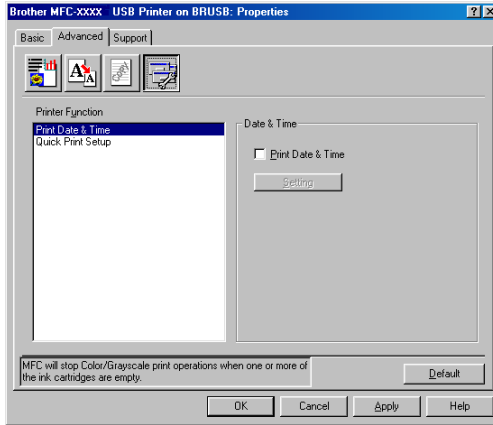

Print Date & Time

When enabled the **Print Date and Time** feature will print the date and time on your document from your computer's system clock.

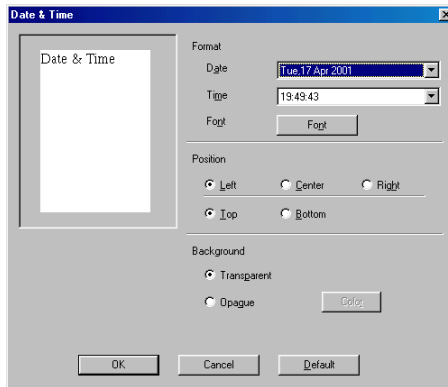

Click the **Setting** button to change the **Date** and **Time** format, and the **Position** and **Font**. To include a background with the **Date** and **Time**, select **Opaque**. When **Opaque** is selected, you can click on the **Color** button to change the color of the **Date** and **Time** background.



The **Date** and **Time** in the selection box shows the format that will be printed. The actual **Date** and **Time** printed on your document is automatically retrieved from the settings of your computer.

Quick Print Setup

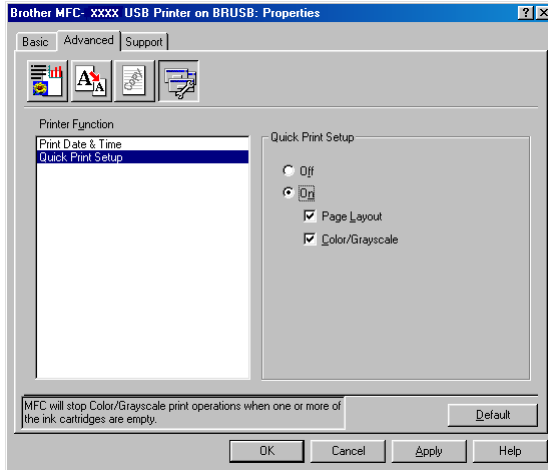

The **Quick Print Setup** feature allows you to quickly select driver settings. To view settings, simply click your mouse button on the task tray icon. This feature can be set to **ON** or **OFF** from the **Device Options**.

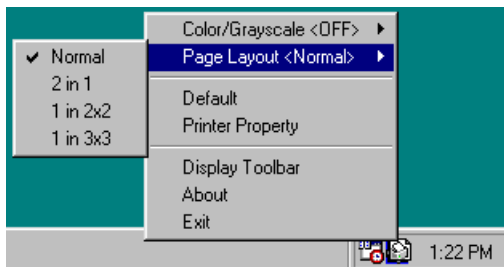

Support tab

The **Support** Tab provides driver version and setting information. In addition there are links to the **Brother Solutions Center** and the Driver Update Web sites.

Click the **Support** tab to display the following screen:

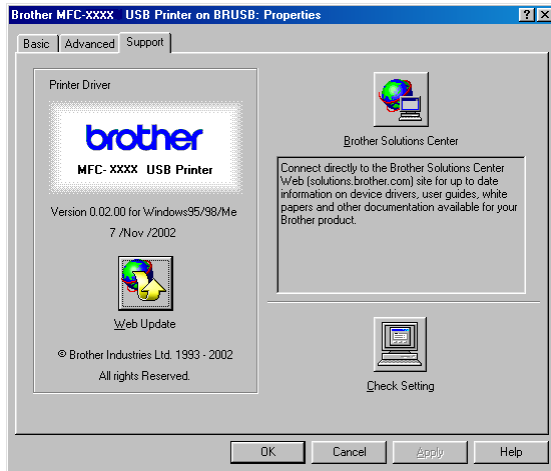

Brother Solutions Center

The **Brother Solutions Center** is a Web site offering information about your Brother product including FAQs (Frequently Asked Questions), User Guides, Driver Updates and Tips for using your machine.

Web Update

Web Update checks the Brother web site for updated drivers, and automatically downloads and updates the printer driver on your computer.

Check Setting

The **Check Setting** selection displays a list of your current driver settings.

14 How to scan using Windows®

 The scanning operations and drivers will be different depending on your operating system.

For Windows® 98/98SE/Me and 2000 Professional

The MFC uses a TWAIN Compliant driver for scanning documents from your applications. (See *Scanning a document (For Windows® 98/98SE/Me and 2000 Professional)* on page 14-1 and *TWAIN compliant* on page 14-1.)

For Windows® XP

Use Windows® Imaging Acquisition (WIA) for scanning documents. (See *Scanning a document (For Windows® XP only)* on page 14-10.)

 **For ScanSoft®, PaperPort® and TextBridge® OCR**
(See *Using ScanSoft® PaperPort® and TextBridge® OCR* on page 14-20.)

Scanning a document (For Windows® 98/98SE/Me and 2000 Professional)

TWAIN compliant

The Brother Multi-Function Link® Pro software includes a TWAIN compliant scanner driver. TWAIN drivers meet the standard universal protocol for communicating between scanners and software applications. This means that not only can you scan images directly into the PaperPort® viewer that Brother included with your MFC, but you can also scan images directly into hundreds of other software applications that support TWAIN scanning. These applications include popular programs like Adobe® Photoshop®, Adobe® PageMaker®, CorelDraw® and many more.

How to access the Scanner

- 1 Open the software application (ScanSoft® PaperPort®) to scan a document.
-  The instructions for scanning in this Guide are for when you use ScanSoft® PaperPort® 8.0 SE.
- 2 Select **Scan** from the **File** drop-down menu or select the **Scan** button. The **Scan** pane appears in the left panel.
- 3 Select **TWAIN_32 Brother MFL Pro Scanner** from the **Scanner** drop-down list box.
- 4 Click the **Scan** button.

The **TWAIN_32 Brother MFL Pro Scanner Setup** dialog box will appear:

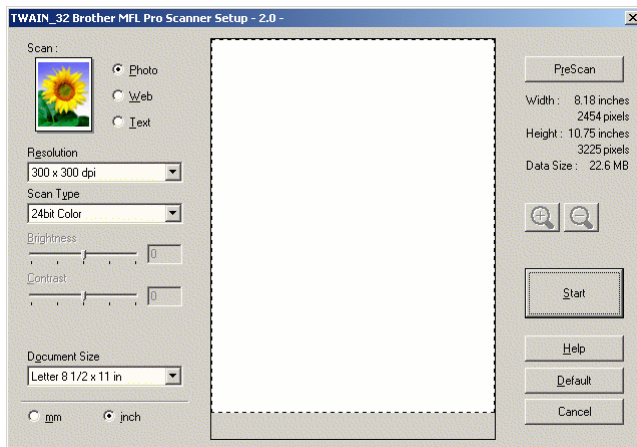

Scanning a document into the PC

You can scan a whole page

—OR—

scan a portion of the page after pre-scanning the document.

Scanning a whole page

- 1 Place the original face down on the scanner glass.
- 2 Adjust the following settings, if required, in the Scanner window:
 - **Scan (Image Type)**
 - **Resolution**
 - **Scan Type**
 - **Brightness**
 - **Contrast**
 - **Document Size**



After you select a document size, you can adjust the scanning area further by clicking the left mouse button and dragging it. This is required when you want to crop an image when scanning.

(See *Settings in the Scanner window* on page 14-6.)

- 3 Click the **Start** button in the scanner window. When scanning is completed, click **Cancel** to return to the PaperPort® window.

PreScanning to crop a portion you want to scan

The **Pre-Scan** button is used to preview an image for cropping any unwanted areas from the image. When you are satisfied with the preview, click the **Start** button in the scanner window to scan the image.

- 1 Place the original face down on the scanner glass.

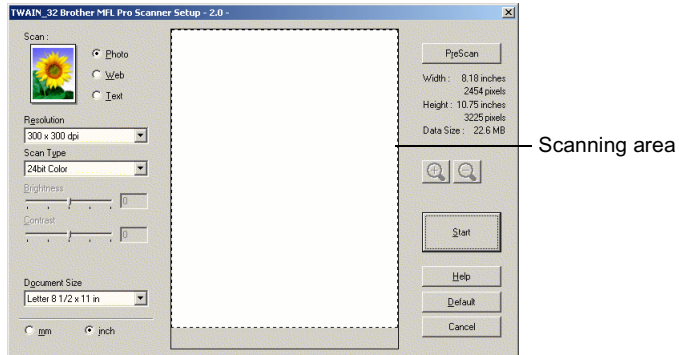



- 2 Select the settings for **Image Type**, **Resolution**, **Scan Type**, **Brightness**, **Contrast** and **Document Size**, as needed.
- 3 In the **TWAIN_32 Brother MFL Pro Scanner Setup** dialog box, click the **PreScan** button.
The entire original will be scanned into the PC and will appear in the Scanning Area.

- 4 Select the portion you want to scan by clicking the left mouse button and dragging it.



Scanning area

 You can enlarge the portion you selected by pressing  to check it. If you want to select the different portion, use  to undo the image.

- 5 Click **Start**.
This time only the selected area of the original will appear in the PaperPort® window (or your software application window).
- 6 In the PaperPort® window, use the options available to refine the image.

Settings in the Scanner window

Scan (Image Type)

Select the image type of output from **Photo**, **Web** or **Text**.

Resolution and **Scan Type** will be altered for each default setting.

The default settings are:

Image Type		Resolution	Scan Type
Photo	Select for scanning photo images.	<i>300 x 300 dpi</i>	<i>24-bit color</i>
Web	Select for attaching the scanned image to web pages.	<i>100 x 100 dpi</i>	<i>24-bit color</i>
Text	Select for scanning text documents.	<i>200 x 200 dpi</i>	<i>Black & White</i>

Resolution

You can change the scanning resolution from the **Resolution** drop down list. Higher resolutions take more memory and transfer time, but can achieve a finer scanned image. The following table shows the resolution you can choose and the available colors.

Resolution	Black & White / Gray (Error Diffusion)	256 color	True Gray / 24 bit color
<i>100 x 100 dpi</i>	Yes	Yes	Yes
<i>150 x 150 dpi</i>	Yes	Yes	Yes
<i>200 x 200 dpi</i>	Yes	Yes	Yes
<i>300 x 300 dpi</i>	Yes	Yes	Yes
<i>400 x 400 dpi</i>	Yes	Yes	Yes
<i>600 x 600 dpi</i>	Yes	Yes	Yes
<i>1200 x 1200 dpi</i>	Yes	No	Yes
<i>2400 x 2400 dpi</i>	Yes	No	Yes
<i>4800 x 4800 dpi</i>	Yes	No	Yes
<i>9600 x 9600 dpi</i>	Yes	No	Yes

Scan Type

Black & White: Set the Scan Type to *Black & White* for text or line art.

Gray Scale: Set the Scan Type to *Gray* or *True Gray* for photographic images.

Colors: Set either:
256 Color, which scans up to 256 colors, or *24-bit color* which scans up to 16.8 million colors.
Although using *24-bit color* creates an image with the most accurate colors, the image file will be approximately three times larger than a file created with *256 Color*.

Brightness

Adjust this settings (-50 to 50) to obtain the best image. The default value is 0, representing an 'average'.

You can set the level by dragging the slide bar to the right or left to lighten or darken the image. You can also type a value in the box for the setting.

If the scanned image is too light, set a lower brightness value and scan the document again. If the image is too dark, set a higher brightness value and scan the document again.



It is only available when *Black & White* or *Grey* is selected.

Contrast

This setting is adjustable only when you have selected one of the gray scale settings. It is not available when *Black & White* and *Color* settings are selected as the *Scan Type*.

You can increase or decrease the contrast level by moving the slide bar to the left or right. An increase emphasizes dark and light areas of the image, while a decrease reveals more detail in gray areas. You can also type a value in the box for the setting.

Document Size

Set the Size to one of the following:

- *Letter (8 1/2 x 11 in.)*
- *A4 (210 x 297 mm)*
- *A5 (148 x 210 mm)*
- *B5 (182 x 257 mm)*
- *Executive (7 1/4 x 10 1/2 in.)*
- *Business Card (90 x 60 mm)*
- *Photo 3.5 x 5 in. (9 x 13cm)*
- *Photo 5 x 7 in. (13 x 18cm)*
- *APS C 4 x 6 in. (10 x 15cm)*
- *Custom (User adjustable from 0.35 x 0.35 in. to 8.5 x 11.69 in.)*

To scan photographs or business cards, select the document size, and then place the document face down at the center of scanner glass.

When scanning photographs or other images for use in a word processor or other graphics application. You should try different settings for the contrast and resolution modes to see which best suits your needs.

If you selected *Custom* as the size, The **Custom Document Size** dialog box will appear.

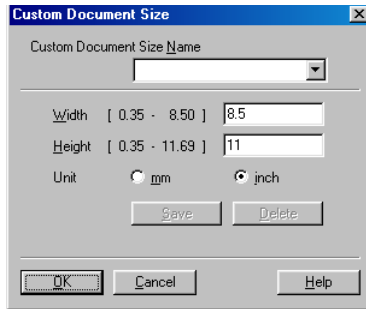

Type the Name, Width and Height for the document.

You can choose 'mm' or 'inch' as the unit for **Width** and **Height**.



You can see the actual paper size you selected on the screen.

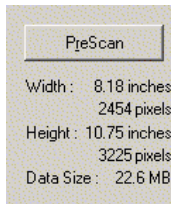

- **Width:** shows the width of scanning area
- **Height:** shows the height of scanning area
- **Data Size:** shows the approximate data size calculated in a Bitmap format. The size will be different for other file formats such as JPEG.

Scanning a document (For Windows® XP only)

WIA compliant

Windows® XP uses Windows Image Acquisition (WIA) for scanning images from the MFC. You can scan images directly into the PaperPort® viewer that Brother included with your MFC or you can scan images directly into any other software application that supports WIA or TWAIN scanning.

How to access the scanner

- 1 Open your software application to scan a document.



The instructions for scanning in this Guide are for when you use ScanSoft® PaperPort® 8.0. The steps for scanning from another application may vary.

- 2 Select **Scan** from the **File** drop-down menu or select the **Scan** button.

The **Scan** panel appears in the left panel.

- 3 Select the scanner you are using from the **Scanner** drop-down list box.

The Scan dialog box will appear:

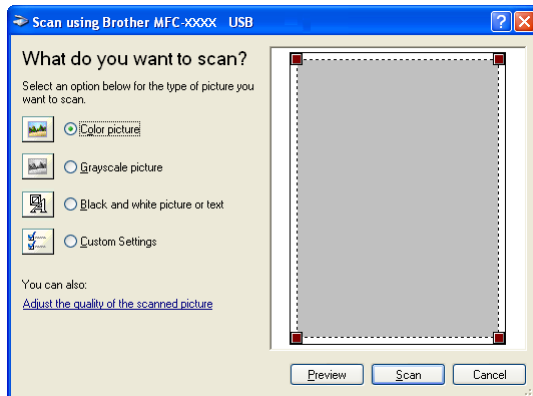

Scanning a document

- 1 Place the original face down on the scanner glass.

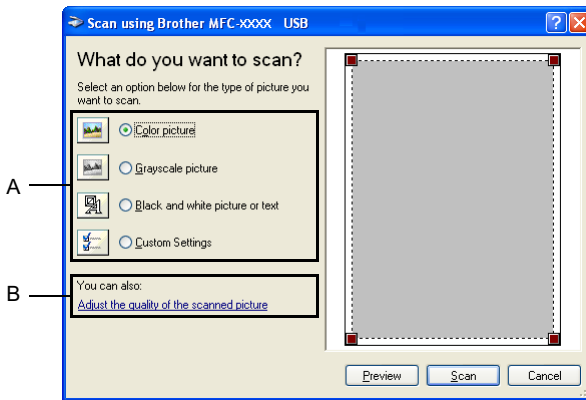

- 2 Select the picture type (A).
- 3 If you require advanced settings, click **Adjust the quality of the scanned picture** (B). You can select **Brightness**, **Contrast**, **Resolution** and **Picture Type** from the **Advanced Properties**. Click the **OK** button after you choose your settings.

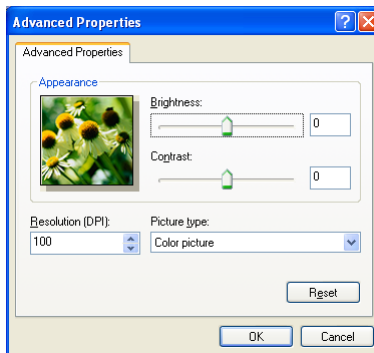

The scanner resolution you can select is up to 1200 x 1200 dpi. To select higher scan resolutions you can use the Brother Scanner Utility. (See *Brother Scanner Utility* on page 14-14.)

- 4 To start scanning your document, click the **Scan** button in the Scan dialog box.

PreScanning to crop a portion you want to scan

The **Preview** button is used to preview an image for cropping any unwanted portions from the image. When you are satisfied with the preview, click the **Scan** button from the scanner window to scan the image.

- 1 Place the original face down on the scanner glass.

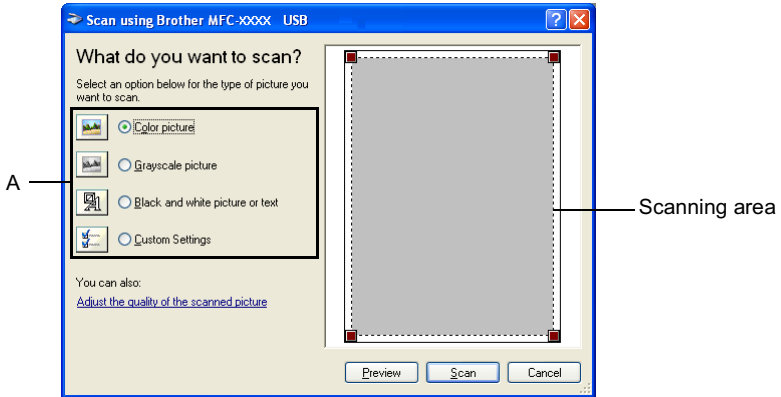

- 2 Select the picture type (A).
- 3 In the Scan dialog box, click the **Preview** button. The entire original will be scanned into the PC and will appear in the scanning area.
- 4 Select the portion you want to scan by clicking the left mouse on the boxes in the corner and dragging it over the area.

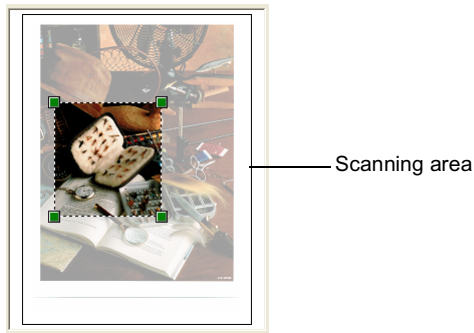

- 5 If you require advanced settings, click **Picture Type** from the **Adjust the quality of the scanned picture** (B). You can select **Brightness, Contrast, Resolution** and **Picture Type** from the **Advanced Properties** tab. Click the **OK** button after you choose your settings.

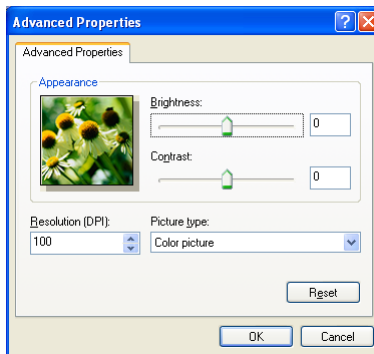
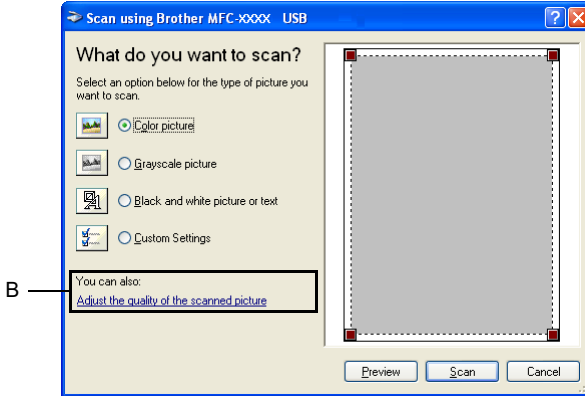

- 6 To start scanning your document, click the **Scan** button in the Scan dialog box.
This time only the selected area of the original will appear in the PaperPort® window (or your software application window).

Brother Scanner Utility

The Brother Scanner Utility is used for configuring the scanner driver for resolutions higher than 1200dpi.

To run the utility:

You can run the utility by selecting the **Scanner Utility** located in the **Start/Programs/Brother/Brother MFL Pro Suite** menu.



Scanning at resolutions greater than 1200dpi may cause problems with some scanning applications.

Using the scan key

You can use the **Scan to** key on the control panel to scan originals into your word processing, graphics or E-mail applications or your computer folder. The advantage of using the **Scan to** key is that you avoid the mouse clicks required to scan from your computer.

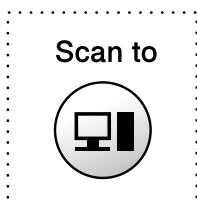

 If you are using a Macintosh[®] computer the **Scan to** key will work only for Scan to Card.

 **For Scan to E-mail, Scan to Image, Scan to OCR and Scan to File only**

Before you can use the **Scan to** key on the control panel, you must have connected the MFC to your Windows[®] based computer and loaded the appropriate Brother Drivers for your version of Windows[®].

When you are ready to use the **Scan to** key, make sure the Brother Control Center application is running on your computer. For details about how to configure the Brother Control Center buttons to launch the application of your choice using the **Scan to** key, go to the appropriate chapter:

- For Windows[®] 98/98SE/Me and 2000 Professional, see *Using the Brother Control Center for Windows[®] 98/98SE/Me/2000 Professional* on page 15-1.
- For Windows[®] XP, see *Using the Windows[®]-Based Brother SmartUI Control Center* on page 16-1.

Scan to E-mail

You can either scan a black and white or color original into your E-mail application as a file attachment. You can change the **Scan to** key configuration. (See *Scan to E-mail* on page 15-7 to 15-8.) (For Windows® XP: See *Hardware Section: Changing the Scan to Button Configuration* on page 16-5 to 16-13.)

1 Place the original face down on the scanner glass.

2 Press the **Scan to** key.

3 Press  to select SCAN TO E-MAIL.

Press **Menu/Set**.

The MFC will scan the original, create a file attachment, and launch your E-mail application, displaying the new message waiting to be addressed.

Scan Image

You can scan a color picture into your graphics application for viewing and editing. You can change the **Scan to** key configuration. (See *Scan to E-mail* on page 15-7 to 15-8.) (For Windows® XP: See *Hardware Section: Changing the Scan to Button Configuration* on page 16-5 to 16-13.)

1 Place the original face down on the scanner glass.

2 Press the **Scan to** key.

3 Press  to select SCAN IMAGE.

Press **Menu/Set**.

The MFC will start the scanning process.

Scan/OCR

If your original is text, you can have it converted by ScanSoft® TextBridge® to an editable text file and then have the result displayed in your word processing application for viewing and editing. You can change the **Scan to** key configuration. (See *Scan to E-mail* on page 15-7 to 15-8.)(For Windows® XP: See *Hardware Section: Changing the Scan to Button Configuration* on page 16-5 to 16-13.)

- 1 Place the original face down on the scanner glass.
- 2 Press the **Scan to** key.
- 3 Press  to select SCAN/OCR.
Press **Menu/Set**.
The MFC will start the scanning process.

Scan to File

You can scan a black and white or a color original into your computer and save it as a file in the folder you choose. The file type and specific folder are based on the settings you have chosen in the Scan to File screen of the Brother MFL-Pro Control Center. (See *Scan to File* on page 15-5.)(For Windows® XP: See *Hardware Section: Changing the Scan to Button Configuration* on page 16-5 to 16-13.)

- 1 Place the original face down on the scanner glass.
- 2 Press the **Scan to** key.
- 3 Press  to select SCAN TO FILE.
Press **Menu/Set**.
The MFC will start the scanning process.

Scan to Card

You can scan black and white and color originals into a media card. Black and white originals will be stored in TIFF file format (*.TIF). Color originals may be stored in PDF (*.PDF) or JPEG (*.JPG) file format. The default setting is COLOR STD and the default file format is PDF. File names default to the current date. For example, the fifth image scanned on July 1, 2002 would be named 07010205.PDF. You can change the color, quality and file name as you want.

Quality	Selectable File Format	Default File Format
B&W STD (STANDARD)	TIFF	TIFF
B&W FINE	TIFF	TIFF
COLOR STD (STANDARD)	JPEG / PDF	PDF*
COLOR FINE	JPEG / PDF	PDF*
COLOR S. FINE	JPEG / PDF	PDF*

 You can choose the default file format in the **Menu, 4, 6** for color files. (See *Changing the default color file format* on page 14-19.)

1 Insert a SmartMedia[®], CompactFlash[®] or Memory Stick[®] card into your MFC.

 Do not take out the media card while the LED on the MFC is blinking to keep from damaging it.

2 Place the original face down on the scanner glass.

3 Press **Scan to**.

4 Press  to select SCAN TO CARD.
Press **Menu/Set**.





5 Press  to select START SCANNING.
Press **Menu/Set**. The MFC will start scanning.

—OR—

Press  to select CHANGE QUALITY to change the quality.
Press **Menu/Set**. Go to Step 6.

—OR—

Select CHANGE FILE NAME to change the file name.
Press **Menu/Set**. Go to Step 7.

- 6** Press  to select the quality you want.
 Press **Menu/Set**.
 If you selected COLOR STD, COLOR FINE or COLOR S.FINE, press  to select the file format (PDF or JPEG).
 Press **Menu/Set**.
 —OR—
 To start scanning, press  to select START SCANNING.
 Press **Menu/Set**.
 —OR—
 To change the file name, go to Step 7.
- 7** If you selected CHANGE FILE NAME, press **1** to select 1.CHANGE.
 Use the dial pad to enter the file name.
 Press **Menu/Set**. (You can only change the first 6 digits.)
 Press  to select START SCANNING.
 Press **Menu/Set**.



When the MFC has finished scanning the page, the LCD shows:
 Place the next page to be scanned, and then press **Menu/Set**.
 —OR—
 Press **Scan to** to exit.

NEXT:PRESS SET
END:PRESS SCAN

Changing the default color file format

- 1** Press **Menu/Set, 4, 6**.
2 Press  to select PDF or JPEG.
 Press **Menu/Set**.
3 Press **Stop/Exit**.

PHOTOCAPTURE
6.SCAN TO CARD

Using ScanSoft® PaperPort® and TextBridge® OCR

ScanSoft® PaperPort® for Brother is a document management application. You will use PaperPort® to view scanned documents. PaperPort® has a sophisticated, yet easy-to-use, filing system that will help you organize your graphics and text documents. It allows you to combine or “stack” documents of different formats for printing, faxing or filing.

ScanSoft® PaperPort® can be accessed through the ScanSoft® PaperPort® program group.

See *Documentation for Multi-Function Link® Pro on the CD-ROM.*

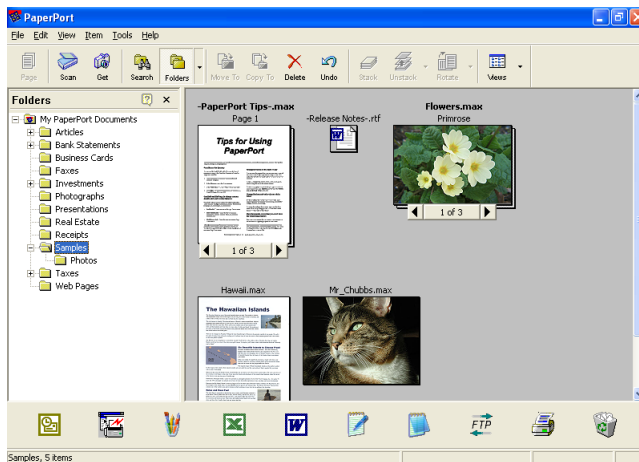

The complete ScanSoft® PaperPort® Users Guide, including ScanSoft® TextBridge® OCR, is in the Documentation on the CD-ROM.

This chapter is only an introduction to the basic operations.

When you install Multi-Function Link® Pro, ScanSoft® PaperPort® for Brother and ScanSoft® TextBridge® OCR are installed with it automatically.

 If you are using Windows® XP or Windows® 2000 Professional, we recommend that you are logged on as an administrator.

Viewing items

ScanSoft® PaperPort® provides several ways to view items:

Desktop View displays a thumbnail (a small graphic that represents each item in a Desktop or folder).

Items in the selected folder appear on the PaperPort® Desktop. You can see PaperPort® items (MAX files) and non-PaperPort® items (files created using other applications).

Non-PaperPort® items include an icon that indicates the application that was used to create the item; a non-PaperPort® item is represented by a small rectangular thumbnail and not an actual image.

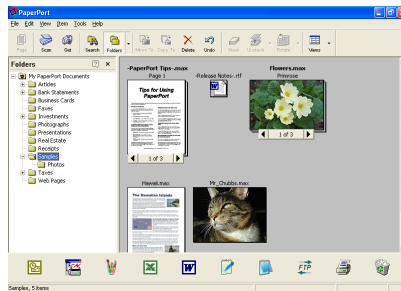

Desktop View displays items as thumbnails

Page View displays a close-up of a single page and you can open a PaperPort® item by double-clicking on it.

As long as you have the appropriate application on your computer to display it, you can also double-click a non-PaperPort® item to open it.

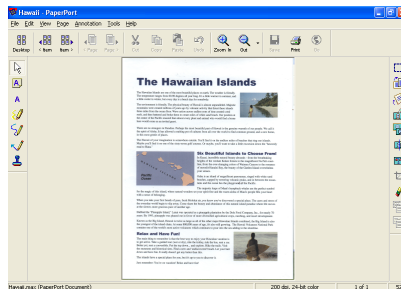

Page View displays each item as a full page

Organizing your items in folders

PaperPort® has an easy-to-use filing system for organizing your items. The filing system consists of folders and items that you select to view in **Desktop View**. An item can be a PaperPort® item or a non-PaperPort® item:

- Folders are arranged in a “tree” structure in the Folder View. You use this section to select folders and view their items in Desktop View.
- You can simply drag and drop an item onto a folder. When the folder is highlighted, release the mouse button and the item is stored in that folder.
- Folders can be “nested”—that is, stored in other folders.
- When you double-click a folder, its items (both PaperPort® MAX files and non PaperPort® files) appear on the Desktop.
- **You can also use Windows® Explorer to manage the folders and items shown in Desktop View.**

Quick links to other applications

ScanSoft® PaperPort® automatically recognizes many other applications on your computer and creates a “working link” to them. The Send To Bar at the bottom of the Desktop view shows icons of those linked applications.

To use a link, drag an item onto one of the icons to start the application represented by the icon. A typical use of the Send To Bar is to select an item and then fax it.

This sample Send To Bar shows several applications with links to PaperPort®.



If PaperPort® does not automatically recognize one of the applications on your computer, you can manually create a link using the **Add to Send To Bar...** command.

(See PaperPort® in the Documentation on the CD-ROM for more information about creating new links.)

ScanSoft® TextBridge® OCR lets you convert image text in to text you can edit

Software by:



ScanSoft® TextBridge® OCR is installed automatically with PaperPort® when you install Multi-Function Link® Pro on your computer.

ScanSoft® PaperPort® can quickly convert the text on a ScanSoft® PaperPort® item (which is really just a picture of the text) into text that you can edit with a word processing application.

PaperPort® uses the optical character recognition application ScanSoft® TextBridge®, which comes with PaperPort®.

—OR—

PaperPort® uses your application if it is already on your computer. You can convert the entire item, or by using the **Copy Text** command, you can select only a portion of the text to convert.

Dragging an item onto a word-processing link icon starts PaperPort®'s built-in OCR application, or you can use your own OCR application.



You can Import items from other applications

In addition to scanning items, you can bring items into PaperPort® in a variety of ways and convert them to PaperPort® (MAX) files in several different ways:

- Print to the Desktop View from another application, such as Microsoft Excel.
- Import files saved in other file formats, such as Windows® Bitmap (BMP) or Tag Image File Format (TIFF).

You can Export items in other formats

You can export or save PaperPort® items in several popular file formats, such as BMP, JPEG, TIFF, or self-viewing.

For example, to create a file for an Internet Web site, export it as a JPEG file. Web pages often use JPEG files for displaying images.

Exporting an image file

- 1 Select the Save As command from the File pull-down menu in the PaperPort® window. The Save 'XXXXX' As dialog box will be displayed.
- 2 Select the drive and directory where you want to store the file.
- 3 Enter the new file name and choose the file type or select a name from the File Name text box. (You can scroll through the Directories and File Name listing for prompting.)
- 4 Select the OK button to save your file, or Cancel to return to the PaperPort® without saving it.



To Uninstall PaperPort® and ScanSoft® TextBridge

For Windows® 98/98SE, and Windows® Me:

Select **Start, Settings, Control Panel, Add/Remove Programs** and the **Install/Uninstall** tab.

Select **Brother Extensions for Paperport** and click the **Add/Remove** button.

Select **PaperPort® 8.0 SE** from the list and click the **Add/Remove** button.

For Windows® 2000 Professional:

Select **Start, Settings, Control Panel** and **Add/Remove Programs**.

Select **Brother Extensions for Paperport** and click the **Change/Remove** button.

Select **PaperPort® 8.0 SE** from the list and click the **Change** button.

For Windows® XP:

Select **Start, Control Panel, Add or Remove Programs** and the **Change or Remove Programs** icon.

Select **PaperPort® 8.0 SE** from the list and click the **Change** button.

15 Using the Brother Control Center for Windows® 98/98SE/Me/2000 Professional

- If you are using Windows® 2000 Professional, we recommend that you are logged on as an administrator.

Brother MFL-Pro Control Center

The Brother Control Center is a software utility that pops up on the PC screen whenever you right-click the Control Center  icon in the Task Tray and select **Show**. This lets you configure the **Scan to** key on your MFC. For example, you can change the default scanning settings, such as resolution, color mode and application.

- For information about the **Scan to** key, See *Using the scan key* on page 14-15.





AutoLoad the Brother Control Center

The Control Center is loaded every time Windows® is started.



When the Control Center is loaded, the Control Center  icon will appear on the task bar.

If you don't want the Control Center to load automatically, you can turn off AutoLoad.

 If the Control Center  icon does not appear on your task bar, you will have to launch it.

Double-click the SmartUI  icon on the desktop or from the **Start** menu, select **Programs, ScanSoft PaperPort 8.0**, and then click **Brother SmartUI POPUP**.

How to turn off AutoLoad

- 1 Left-click the Control Center  icon and click **Show**.
- 2 When the Control Center window appears, left-click the **Smart Click  Control Center** button.
A dialogue box will appear:

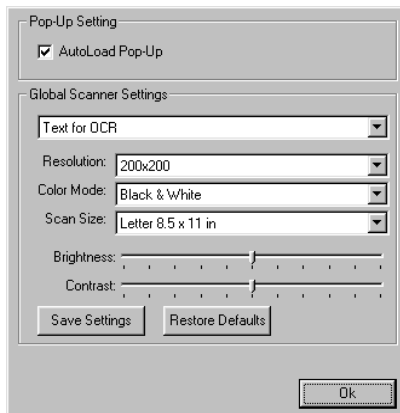

- 3 Uncheck the **'AutoLoad' Pop-Up** check box.



Brother Control Center features

Auto Configuration

During installation the Control Center will check your system to set up the default applications for E-mail, word processing and the graphics viewer/editor.

For example, if you are using Outlook as your default E-mail application, the Control Center will create a link and a scanning application button for Outlook.

You can change the default application. Right-click the appropriate Control Center button to display *Configuration* and then click on it. Select a different application.

For example, you can change a scan button from MS Word Pad  to MS Word  by changing the application that is listed for the Word Processor.

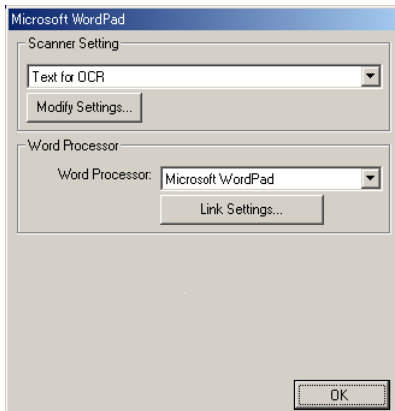

Scan to key operations

Scan to File—Lets you to scan directly to a file on your computer. You can change the file type and directory for the document you are scanning.

Scan to E-mail—Lets you scan a picture or text document directly into an E-mail application as a standard attachment. You can choose the file type and resolution for the attachment.

Scan to OCR (Word Processor)—Lets you to scan a text document, run ScanSoft TextBridge OCR, and insert the text original (not a graphic image) into a word processing file. You can choose the word processing application, such as Word Pad, MS Word, Word Perfect, and so on.

Scan Image—Lets you to scan an image directly into any graphic viewer/editor application. You can choose the graphics application, such as Microsoft Paint or Corel PhotoPaint.

Scan to File

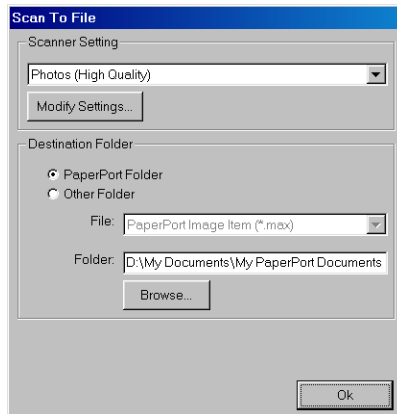

To access Scan to File Configuration screen

- 1 In the Task Tray right-click the Control Center  icon and select **Show** to access the Brother Control Center window.
- 2 Right-click **Scan to File** button and then click on *Configuration*. Click the **Modify Settings** button to view the configuration screen of the **Control Center**.
- 3 To save your settings, click **OK**
—OR—
To go back to the factory default settings, click the **Restore Defaults** button.

Scanner Settings

From the pull-down list, select the scanning mode that is appropriate for the type of file: *Text for OCR*; *Photos*; *Photos (High Quality)*; *Photos (Quick Scan)* or *Custom*.

To change any of the settings for the mode, click **Modify Settings**.

Destination folder

PaperPort Folder—Select this check box to scan the original into your PaperPort folder.

Other Folder—Select this check box, to scan the original as another file type or to store it in another directory/folder.

File—If you selected Other folder from the pull-down list, select the type of file:

- PaperPort Image Item (*.max)*
- PaperPort Self-Viewing (*.exe)*
- PaperPort Browser-Viewable (*.htm)*
- PaperPort 5.0 Image Item (*.max)*
- PaperPort 4.0 Image Item (*.max)*
- PaperPort 3.0 Image Item (*.max)*
- Windows Bitmap (*.bmp)*
- PC Paintbrush (*.pcx)*
- PCX Multi-page (*.dcm)*
- JPEG (*.jpg)*
- TIFF-Uncompressed (*.tif)*
- TIFF-Group 4 (*.tif)*
- TIFF-Class F (*.tif)*
- TIFF Multi-page - Uncompressed (*.tif)*
- TIFF Multi-page - Group 4 (*.tif)*
- TIFF Multi-page - Class F (*.tif)*
- Portable Network Graphics (*.png)*
- FlashPix (*.fpx)*

To Search your system for the directory and folder you want, click the **Browse** button. Click **OK** to save your settings.

Scan to E-mail

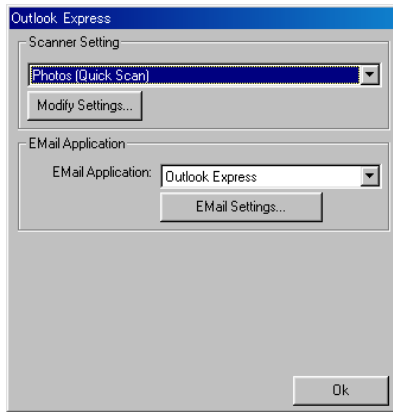

To access Scan to E-mail Configuration screen

- 1 In the Task Tray right-click the Control Center  icon and select **Show** to access the Brother Control Center window.
- 2 Right-click the E-mail application button and click on *Configuration*. Click the **Modify Settings** button to view the configuration screen of the **Control Center**.
- 3 To save your settings, click the **OK** button
—OR—
To go back to the factory default settings, click the **Restore Defaults** button.

Scanner Settings

From the pull-down list, select the scanning mode that is appropriate for the type of file: *Text for OCR*; *Photos*; *Photos (High Quality)*; *Photos (Quick Scan)* or *Custom*.

To change any of the settings for this mode, click **Modify Settings**.

E-mail application

E-mail Application—From the pull-down list, select your E-mail application.

E-mail Settings—Click the **E-Mail Settings** button to set up links. The **Send To Options** window will appear:

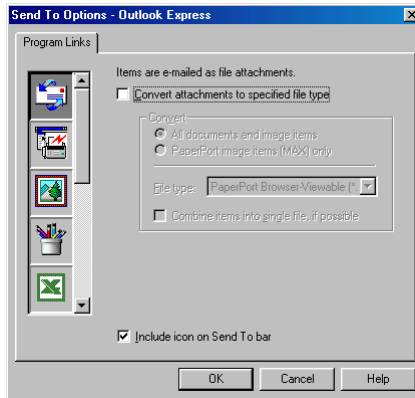

Send to Options

Convert attachments to specified file type—Converts items to the type in the **File Type** box. Clear this check box to keep files in their source format; for example, to keep Word documents in the .doc format and JPEG images in the .jpg format.

All documents and image items—Converts all items regardless of the program in which the item was created; for example, converts all Word (doc) files and JPEG (.jpg) files to the file type.

PaperPort image items (max) only—Converts only PaperPort image items (.max) files. PaperPort does not convert other file types, such as JPEG images and Word documents.

File type—Identifies the format in which to convert items; for example, JPEG or TIFF.

Combine items into a single file, if possible—Combines all selected items into a single file that contains multiple pages. This option is available only when the file type supports multiple pages, such as multi-page TIFF.

Scan to OCR (Word Processor)



To access Scan to OCR Configuration screen

- 1 In the Task Tray right-click the Control Center  icon and select **Show** to access the Brother Control Center window.
- 2 Right-click the word processor application button and click on *Configuration*. Click the **Modify Settings** button to view the configuration screen of the **Control Center**.
- 3 To save your settings, click the **OK** button
—OR—
To go back to the factory default settings, click the **Restore Defaults** button.

Scanner Settings

From the pull-down list, select the scanning mode that is appropriate for the type of file: *Text for OCR*; *Photos*; *Photos (High Quality)*; *Photos (Quick Scan)* or *Custom*.

To change any of the settings for this mode, click **Modify Settings**.

Word Processor

Word Processor—From the pull-down list, select the word processor you want to use.

Click the **Link Settings** button to display the screen to set up the document format you want to use and identify the OCR program:

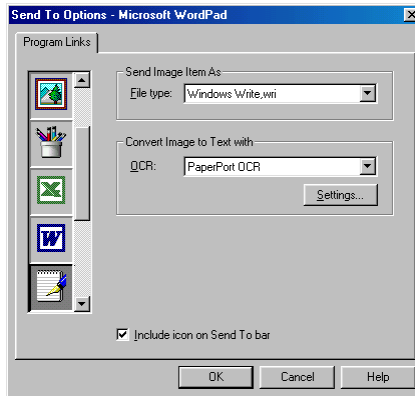

File Type—From the pull-down list, select the file type you want to use for your word processor or text documents.

OCR—Identify the OCR program to use to convert scanned document images to editable documents. This option is available only when you have an OCR program other than the one provided with PaperPort. (PaperPort 8.0 uses the same OCR engine that is in ScanSoft's TextBridge Pro Millennium product.)

Click the **Settings** button to choose how the OCR application will read the pages that you scan into your word processor application.

The **OCR Settings** window will appear:

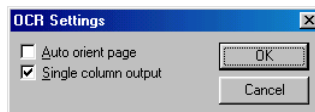

Select your setting and click **OK**.

- **Auto orient page**—Click this check box to automatically rotate pages so that the text is upright.
- **Single column output**—Click this check box if you want to remove columns from multi-column documents so that converted text appears in a one-column format.

Scan Image

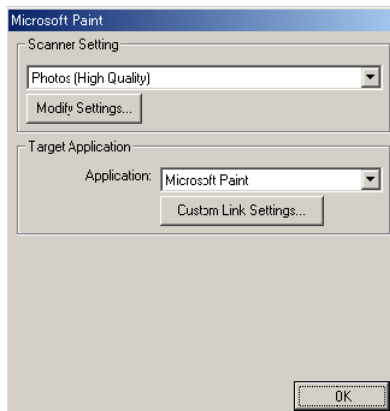

To access Scan to Image Configuration screen

- 1 In the Task Tray right-click the Control Center  icon and select **Show** to access the Brother Control Center window.
- 2 Right-click the graphic application button and click on *Configuration*. Click the **Modify Settings** button to view the configuration screen of the **Control Center**.
- 3 To save your settings, click the **OK** button
—OR—
To go back to the factory default settings, click the **Restore Defaults** button.

Scanner Settings

From the pull-down list, select the scanning mode that is appropriate for the type of file: *Text for OCR*; *Photos*; *Photos (High Quality)*; *Photos (Quick Scan)* or *Custom*.

To change any of the settings for this mode, click **Modify Settings**.

Target Application

Application—From the pull-down list, select the application you want to add to this Pop-Up screen.

Click the **Custom Link Settings** button to set up links for your user-defined application.

16 Using the Windows®-Based Brother SmartUI Control Center

(For Windows® XP)

Brother SmartUI Control Center

The Brother Control Center is a software utility that allows you to quite easily, with very few mouse clicks, access the most frequently used scanning applications. Using the Control Center eliminates the need to manually launch the specific applications and allows you to scan a document directly to a folder on your computer. The Brother Control Center provides four categories of operations:

- 1 Scan directly to a file, E-mail, word processor or graphics application of your choice.
- 2 Enhanced copy functions.
- 3 PC Fxing using the Brother PC-Fax software.
- 4 Custom buttons allow you to configure a button to meet you own application requirements.

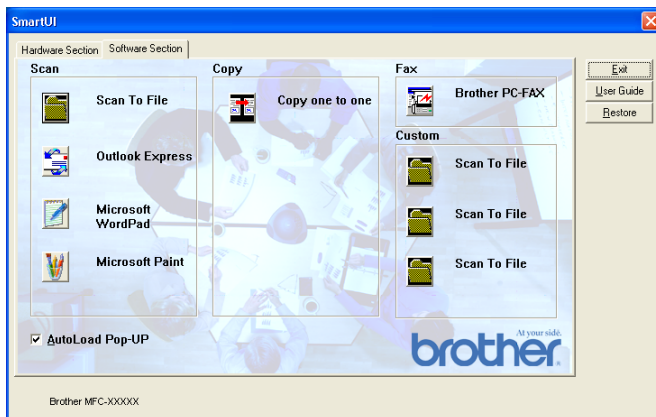

In the Task Tray right-click on the Control Center  icon and select **Show** to have access to the Brother SmartUI Control Center window.



For information about the **Scan to** key, see *Using the scan key* on page 14-15.

AutoLoad the Brother Control Center

The Control Center is initially configured to automatically load each time Windows® is started. When the Control Center is loaded the Control Center  icon will appear in the task bar. If you don't want the Control Center to load automatically, you can turn AutoLoad off.

How to turn off Auto Load

- 1 right-click the Control Center  icon in the Task Tray and select **Show**.
- 2 The main SmartUI Control Center window appears. Please look at the bottom of the window for a check box labeled “AutoLoad Pop-up”.

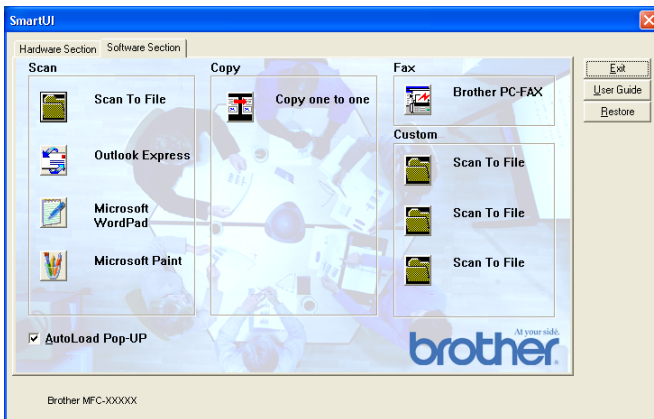

- 3 Uncheck the AutoLoad Pop-Up option to prevent the SmartUI from automatically loading every time Windows is started.

Brother Control Center features

The SmartUI control center gives you the ability to configure the hardware **Scan to** key on your MFC such as “Scan to File”. The “Scan to File” feature allows you to scan a document directly to your hard disk and choose the file format and destination folder without having to run any other applications. Select which section you want by clicking on the appropriate tab.

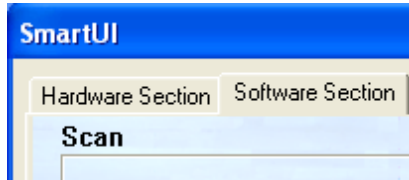

Auto Configuration

During the installation process the Control Center checks your system to determine the default applications for E-mail, word processing and graphics viewer/editor.

For example, if you are using Outlook as your default E-mail application, the Control Center automatically will create a link and a scanning application button for Outlook.

You can change the default application by right-clicking on any of the scan buttons in the Control Center and then clicking *Configuration*. Select the Configuration tab and from the Application pull down menu select a different application. For example, you can change the E-mail scan button from Outlook Express to Outlook by changing the application that is listed.

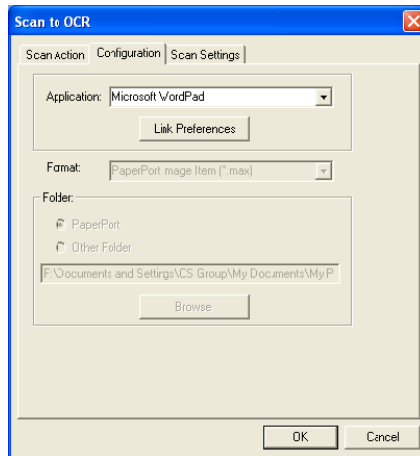

Hardware Section: Changing the Scan to Button Configuration

When the SmartUI Control Center is displayed, you can access the Hardware Section window to reconfigure the **Scan to** key on your MFC. Click the Hardware Section tab at the top left of the SmartUI Control Center screen. (See *Using the scan key* on page 14-15.)

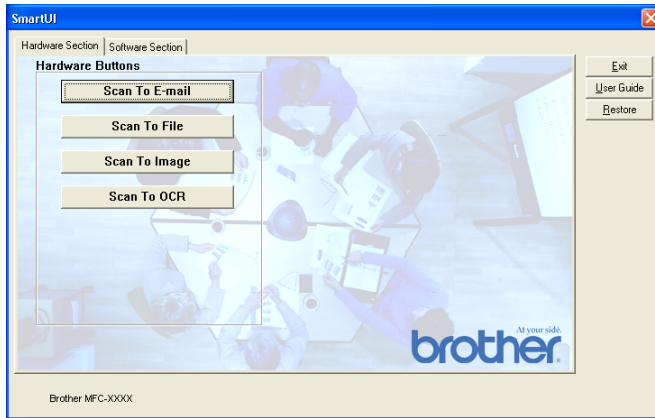

Scan To E-mail

To configure the Scan to E-mail feature left-click on the **Scan to E-mail** button and the following screen will appear. You have the ability to change the configuration that includes the destination E-mail application, attachment file and the scanner settings.

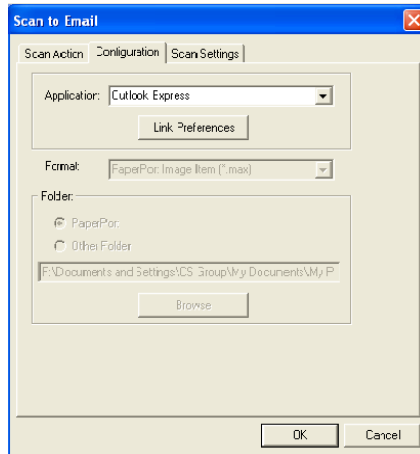

To change the destination E-mail application you use the Application pull down list to select the compatible E-mail application, which is installed on your system.

If you wish to change the attachment file type click on the **Link Preferences** button to display a list of file types.

Scan To File

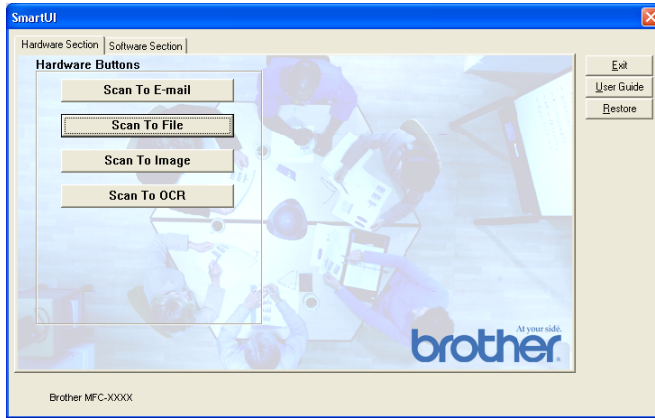

To configure the Scan to File feature, left click on the **Scan to File** button and the following screen will appear.

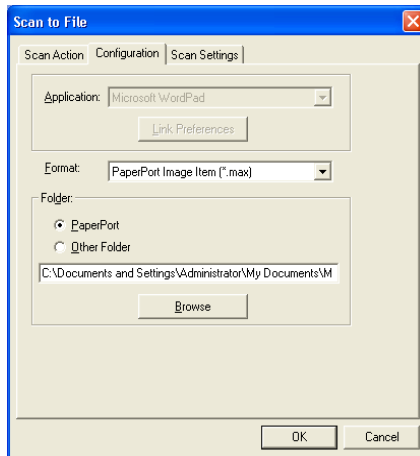

Select the file type for the saved image by selecting from the Format pull down list. You can save the file to the default PaperPort folder so the file appears in PaperPort or you can select another folder/directory by clicking the Browse button.

Scan To Image

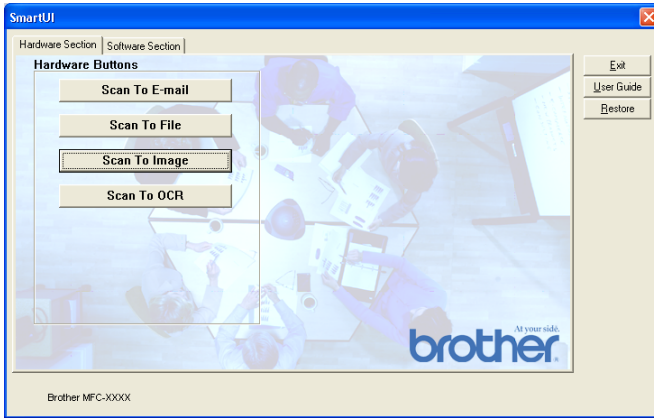

To configure the Scan to Image feature left-click on the **Scan to Image** button and the following screen will appear. You have the ability to change the configuration, which includes the destination image format or document application.

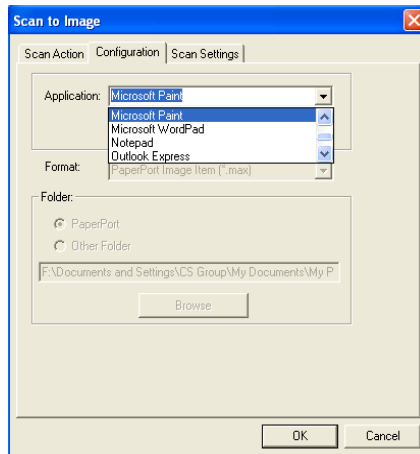

To change the default setting of the scan, click on the **Scan Settings** tab.

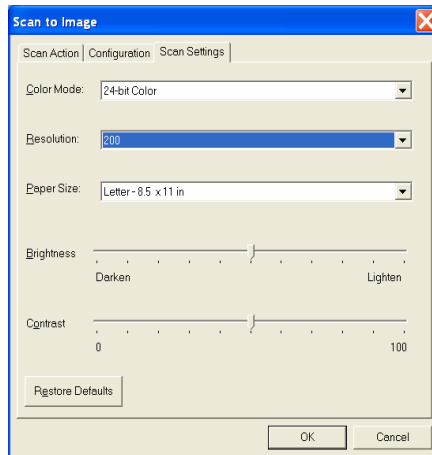

You can set the Color Mode to Black & White, 8-bit Gray or 24-bit Color.

The resolution can be changed from 100 to 1200 dpi. You can define the size of the paper you're using, and you can adjust the brightness and contrast of the image before scanning.

Scan To OCR

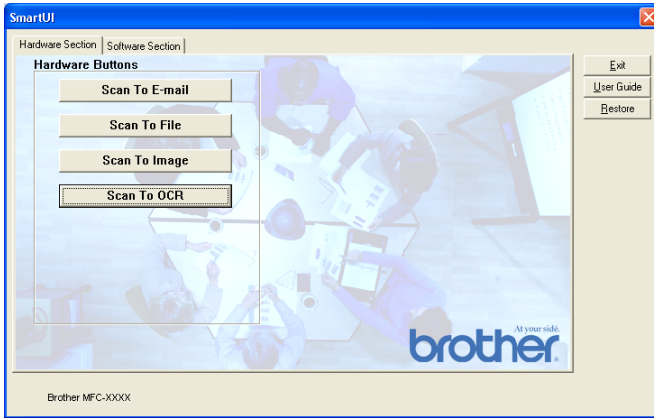

To configure the Scan to OCR feature left-click on the **Scan to OCR** button and the following screen will appear. You have the ability to change the configuration, which includes the destination applications.

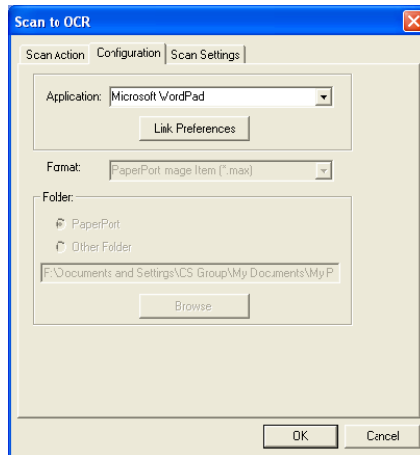

If you wish to send your scan as a different file type, click on **Link Preferences** button. You can select the application from the File Type window according to your needs.

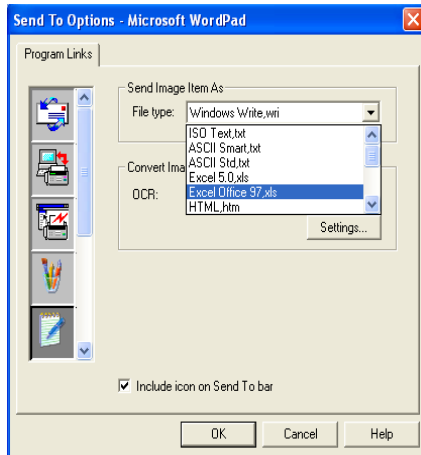

You have the option to choose your OCR setting from **Single column output** to **Auto orient page**.

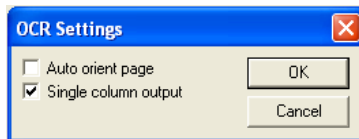

Software Section

The Software Section contains four groups of scan to buttons. Each section has a number of different buttons which are predefined for the most frequently used applications. The **Scan** section contains four buttons for Scan to File, Scan to E-mail, Scan to Word Processor and Scan to Image applications. The **Copy** section contains one button for one to one copying. The **Fax** section button is for sending faxes using the Brother PC-FAX application and the **Custom** section contains three buttons with which you can assign your own function.

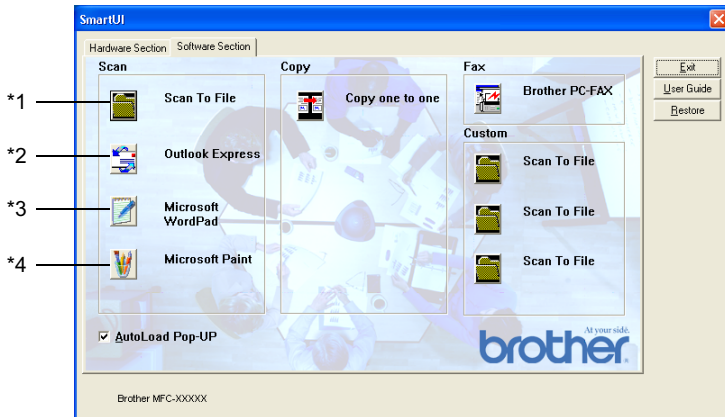

Scan

*1 *Scan to File* —enables you to scan directly to a disk file. You can change the file type and destination directory, as needed.

*2 *Scan to E-mail (Default: Outlook Express)* —enables you to scan a page or document directly into an E-mail application as a standard attachment. You have the option of selecting the file type and resolution for the attachment.

*3 *Scan to Word Processor (Default: MS WordPad)* —enables you to scan a page or document, automatically run ScanSoft TextBridge OCR and insert the text (not graphic image) into a word processing program. You have the option of selecting the destination word processing program, such as WordPad, MS Word, Word Perfect or whichever word processing program is installed on your computer.

*4 *Scan to Graphic Application (Default: MS Paint)* —enables you to scan a page directly into any graphic viewer/editor application. You can select the destination application, such as MS Paint, Corel PhotoPaint, Adobe PhotoShop, or any kind of image editor application you already have installed on your computer.

Copy

Copy (Copy one to one)—allows you to use the PC and any Windows® printer driver for enhanced copy operations. You can scan the page on the MFC and print the copies using any of the features of the MFC printer driver—**OR**—you can direct the copy output to any standard Windows® printer driver installed on the PC including network printers.

Fax

Send a Fax (Brother PC-FAX)—enables you to scan a page or document and automatically send the image as a fax from the PC using the Brother PC-FAX software.

Custom

Scan to File—These buttons have been pre-programmed for the Scan to File feature. You can change the configuration of each of these buttons to meet your specific requirements by right-clicking on a button and following the configuration menus.

Scan to File

The Scan to File button allows you to scan an image and save it in a specific file type to any directory on your hard disk. This allows you to easily archive your paper documents. To configure the file type and save to directory right-click on the Scan to File button and click Configuration.

The Scan Action tab is set to File and should not be changed.

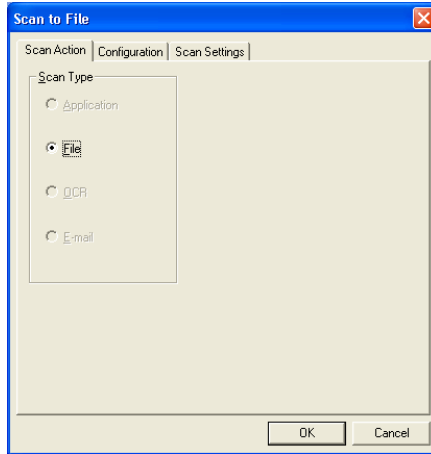

To change the configuration click on the Configuration tab.

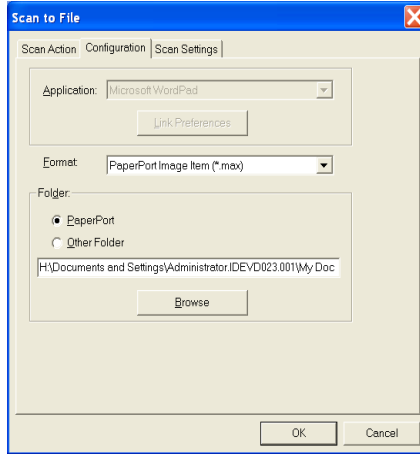

Select the file type for the saved image by selecting from the Format pull down list. You can save the file to the default PaperPort folder so the file appears in PaperPort or you can select another folder/directory by click the Browse button.

You can default setting by selecting the Other Folder button and then clicking Browse and selecting the folder in which you wish to save your files.

Scan to E-mail

The Scan To E-mail is automatically configured to your default E-mail application. To change the default E-mail application or attachment file type right-click on the E-mail button and select “Configuration”.

The Scan Action tab is set to E-mail and should not be changed.

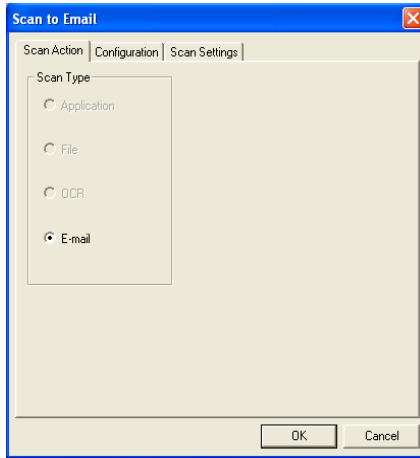

To change the E-mail application click on the Configuration tab. From Application pull down list select your preferred E-mail application.

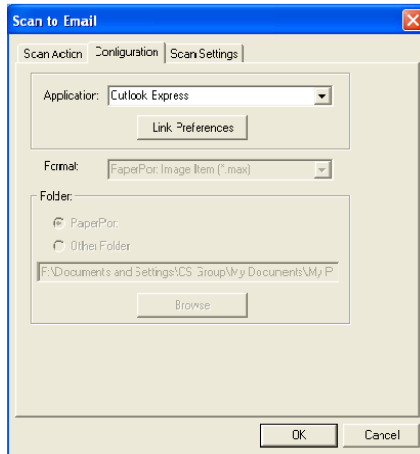

To change the file type of the attachment click the **Link Preferences** button to set up links. Check the **Convert attachments to specified file type** box and then select the appropriate file type from the pull down list.

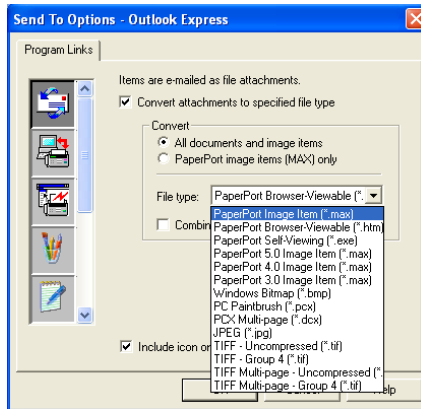

File attachments

Items are mailed as file attachments using the file type you have selected.

Convert attachments to specified file type—Click this check box if you want to change the file type of attachments.

All documents and image items—Click this check box if you want to convert all scanned images to the same file type.

PaperPort image items (MAX) only—Click this check box if you want to convert only attachments that are PaperPort MAX files.

Combine items into single file, if possible—Click this check box if you want to combine all the attachments into one file. With this box unchecked each scanned page will be saved in its own individual file.

File Type—Select from the pull-down list the type of file you want the scanned images to be saved in.

PaperPort Image Item (*.max)

PaperPort Browser-Viewable (*.htm)

PaperPort Self Viewing (*.exe)

PaperPort 5.0 Image Item (*.max)

PaperPort 4.0 Image Item (*.max)

PaperPort 3.0 Image Item (*.max)

Windows Bitmap (*.bmp)

PC Paintbrush (*.pcx)

PCX Multi-page (*.dcm)

JPEG (*.jpg)

TIFF-Uncompressed (*.tif)

TIFF Group 4 (*.tif)

Multi-Page -Uncompressed (*.tif)

Multi-Page - Group 4 (*.tif)

Scanner settings

You have the ability to change the scanner settings used to create the file attachments. Click on the Scan Settings tab and select the appropriate settings.

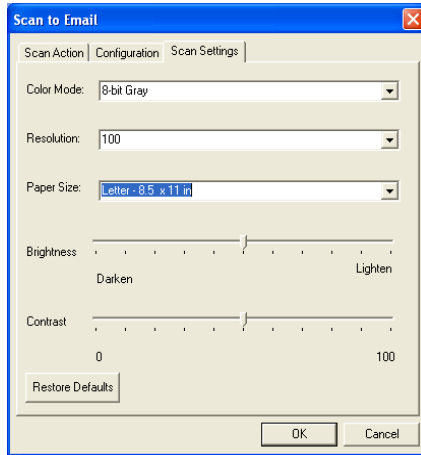

Scan to OCR (Word Processing program)

Scan to OCR converts the graphic page image data to text which can be edited by any word processor program. You can change the default word processor program (example: Word instead of Word Pad) and file type. You can also choose other OCR software package besides the TextBridge OCR which is built in PaperPort. To configure Scan to OCR right-click on the WordPad button and select Configuration. The Scan Action tab is set to OCR and should not be changed.

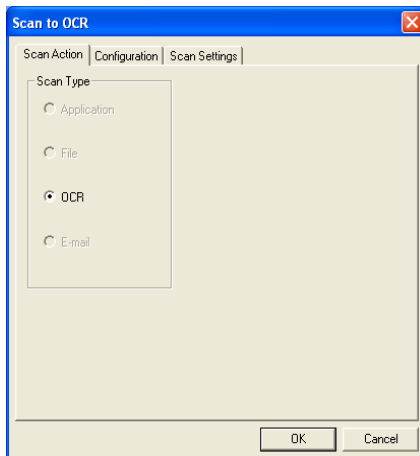

To change the word processing application click on the Configuration Tab. You can select the destination word processing application from the Application pull down list.

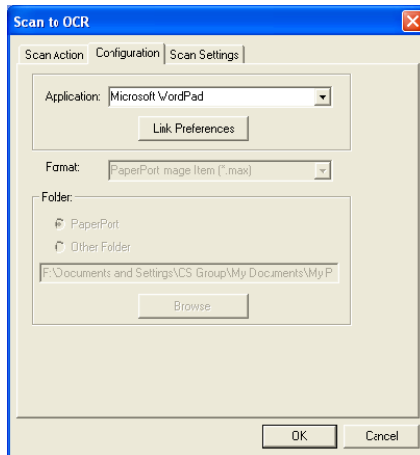

To change the program link preferences click the Link Preferences button.

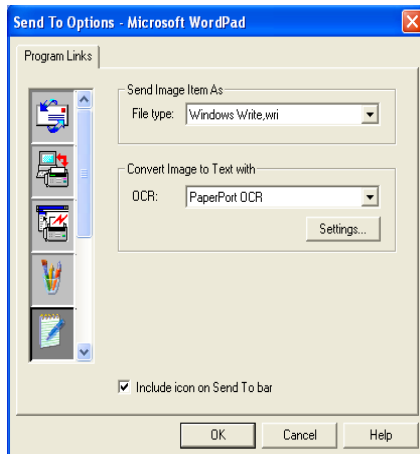

File Type—From the pull-down list, select the file format you want to use for documents.

OCR—Select the OCR application from the OCR pull down list.

Scan to Graphics application (example: Microsoft Paint)

The Scan to Graphics Application allows you to scan an image so you can edit the image. To change the default graphics application right-click on the button and select Configuration.

The Scan Action tab is set to Application and should not be changed.

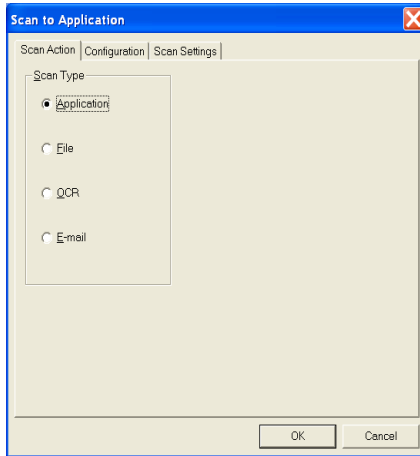

To change the configuration of the destination application click on the Configuration Tab.

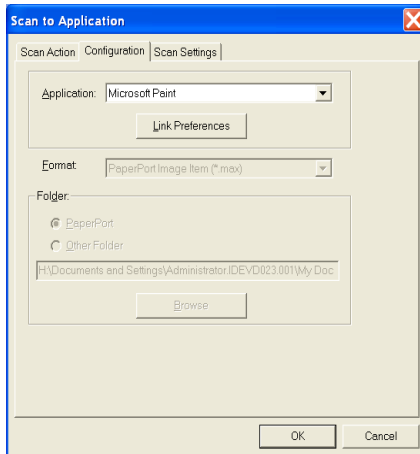

To change the destination application select the appropriate application from the Application pull down list.

To change the other configuration options click the Link Preferences button.

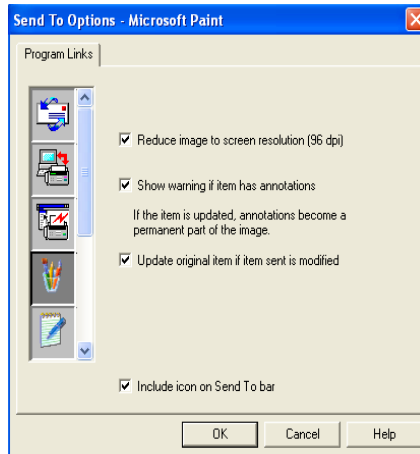

This option enables you to reduce image to screen resolution (96dpi), show warning if item has annotations, update original item if sent item is modified, if needed.

- **Reduce image to screen resolution (96dpi)**—Sets the resolution of your images to 96 dots per inch (dpi). This produces a smaller file with a resolution that is adequate for screen display.
- **Show warning if item has annotations**—Displays a message to alert you that annotations will become a permanent part of an image that contains annotation.
- **Update original item if item sent is modified**—If you save changes to the image in the image editing program, the modified image replaces the original image on the Paper Port desktop.

Copy

The copy button can be customized to allow you to take advantage of the features built into the Brother printer drivers to do advanced copy functions.

The Copy button is automatically linked to the default Windows printer driver. You can set any printer as the default printer including non-Brother printers. Before you can use the Copy button you must first configure the printer driver by right-clicking on a Copy button and selecting Configuration.

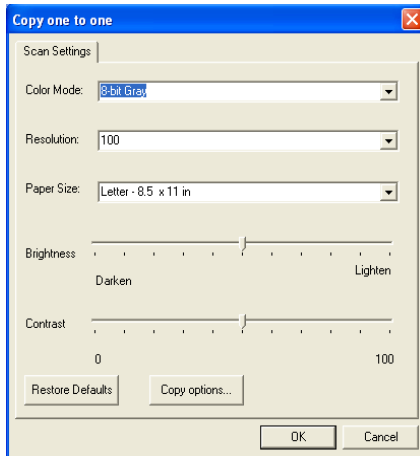

In the Scan Settings window you can select the color mode, resolution, paper size, brightness and contrast settings to be used. (NOTE: Selecting 24-bit Color will give you color output only when the destination printer is a color printer.)

To finish the Copy button configuration you must set the printer driver. Click the Copy options button to display the printer driver settings.

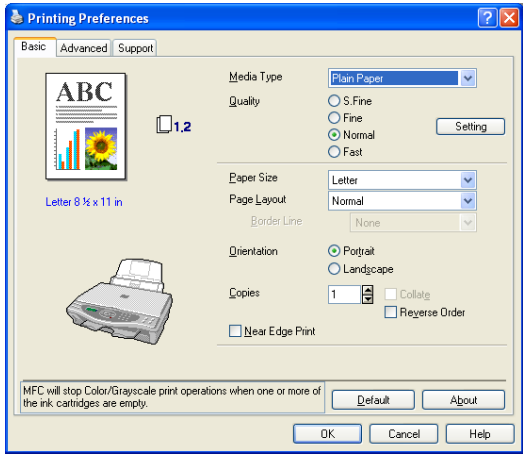

Fax setting (PC-Fax using the Brother Fax Driver)

The MFC includes a PC-Fax driver, which allows any Windows Application to send a Fax as simply as printing a document. The Brother SmartUI automatically configures the Fax button to use the Brother PC-FAX driver no user configuration is required.

The Scan Action tab is set to Application and should not be changed.

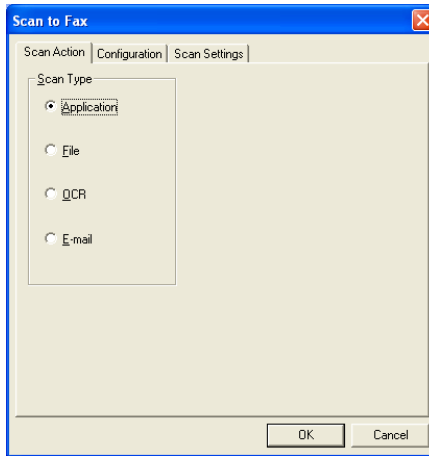

To change the PC-FAX settings click the Link Preferences button.

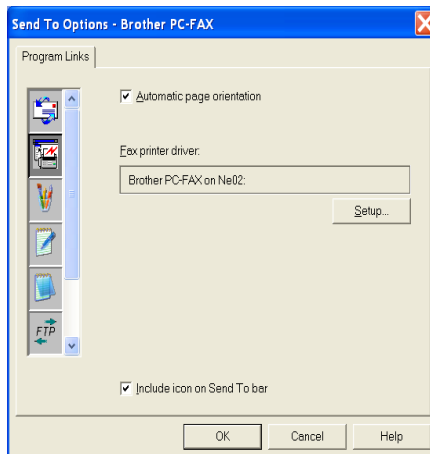

FAX settings

Brother PC-FAX

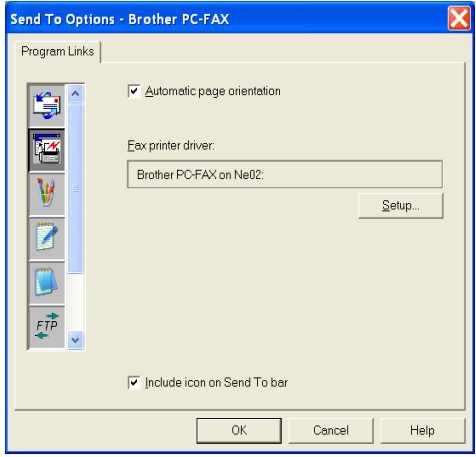

To change the driver settings, click on the Setup button and then the Options button.

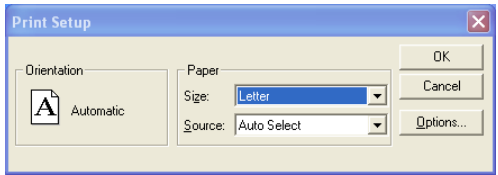

Select the *Paper Size*, *Paper Source*. If you need more customized setup, click on the Options button.

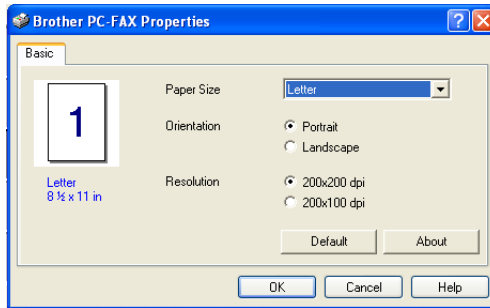

Select the *Paper Size*, Orientation (Portrait or Landscape) and Resolution (200x200 dpi or 200x100 dpi), and click **OK**.

To return to the factory default settings, click the **Defaults** button.

Custom: User-defined buttons

There are up to three Custom buttons on the Brother SmartUI Control Center. You can set your own preferences and configuration to fit your required application.

To configure a Custom Button right click on the button and then click Configuration. The configuration window will appear. You have four function choices Application, File, OCR and Email.

Application: This setting will link the Control Panel button to any button which appears on the PaperPort Send to Bar. Please see the PaperPort help file for more information regarding PaperPort compatible applications.

File: This setting allows you to save a scanned image to any directory on local or network hard disk. You can also select the file format to be used.

OCR: Scanned documents will be converted to editable text files. If you have a third party OCR software package installed on your PC you can select it. The default OCR software is TextBridge which is built into PaperPort 8.0. You can also select the destination word processor and file format for the editable text.

E-mail: Scanned images will be attached to an email message. You can choose which E-mail package to use if you have more than one installed on your system. You can also select the file type for the attachment and create a quick send list of E-mail addresses chosen from your default E-mail address book.

Customizing a user-defined button

To configure a Custom button right-click on the button and then click Configuration. Please follow the following guide lines for Custom Button configuration.

1. Select the Scan Action

Select the type of scan by clicking the appropriate button.

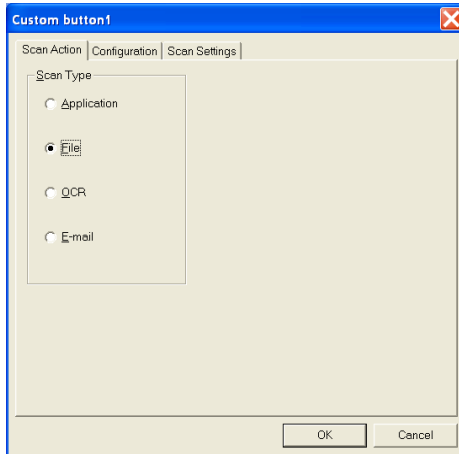

2. Select Configuration for the Scan Type.

To configure the scan operation click on the Configuration Tab. Depending upon which Scan Type button you selected you will see a different Configuration Tab list of settings.

Application:

Select the destination application program from the pull down list.

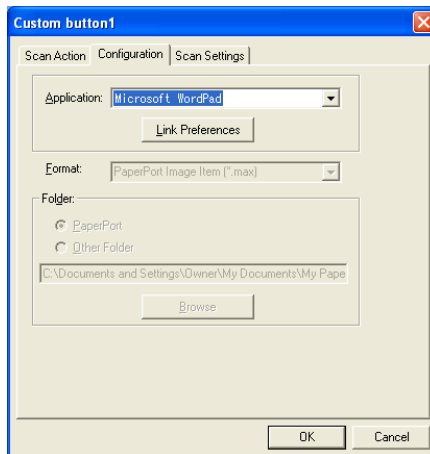

Click on Link Preferences to set the Send to options. You can select the application from the scroll menu on the left.

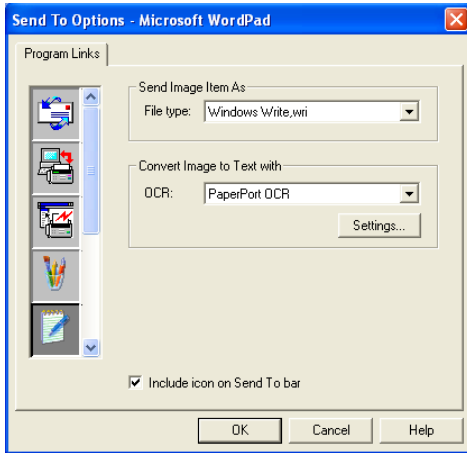

File:

Select the file format from the Format pull down list. You can either send the file to the default PaperPort directory or select your own destination directory by selecting Other Folder. Use the Browse button to select the destination directory.

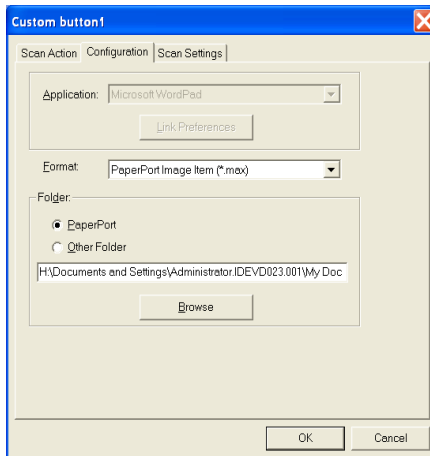

OCR:

Select the destination word processing application program from the pull down list.

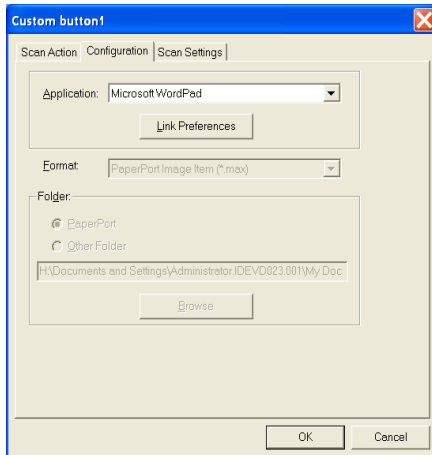

Click on Link Preferences and select the destination Application from the scroll menu on the left. Select the File Type from the File Type pull down list. You can also choose another OCR application from the OCR pull down list if another is installed on you system. Scansoft TextBridge is installed as part of the PaperPort 8.0 application.

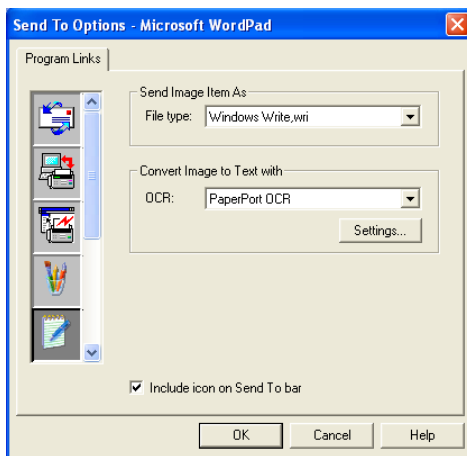

E-mail:

Select the destination E-mail application program from the pull down list.

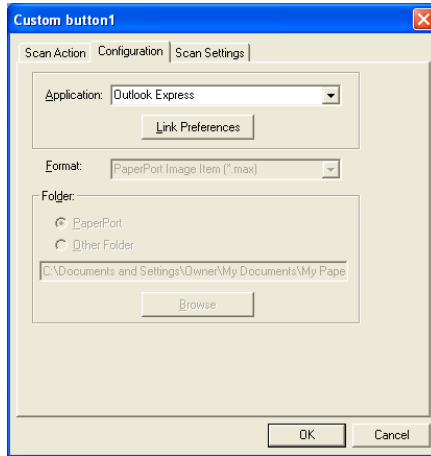

Click on the **Link Preferences** button to configure the Send To E-mail options. You can select the File type and Quick Send E-mail address list.

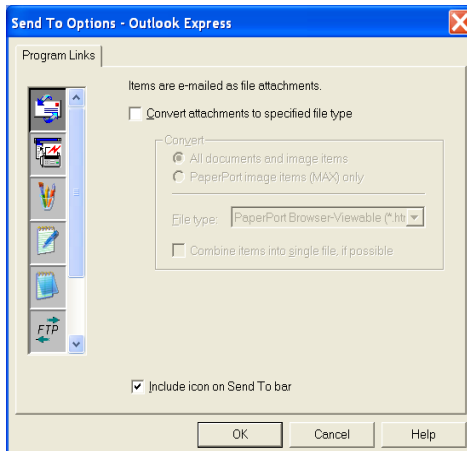

3. Select Scan Settings.

You can select the scanner settings from each of the Scan Type options for the Custom buttons. You have the option to select Color Mode, Resolution, Paper Size and Brightness and Contrast settings.

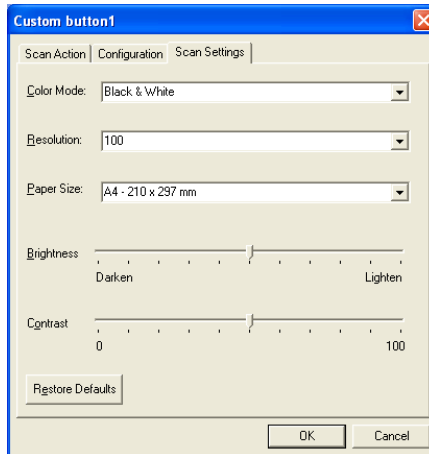

17 Using MFC Remote Setup

(For Windows®)

MFC Remote Setup

The MFC Remote Setup application lets you to set up your MFC by using the ease and speed of programming on your PC. When you access this application, the settings on your MFC will be downloaded to your PC and displayed on your computer screen. If you change the settings, you can upload them directly to the MFC.

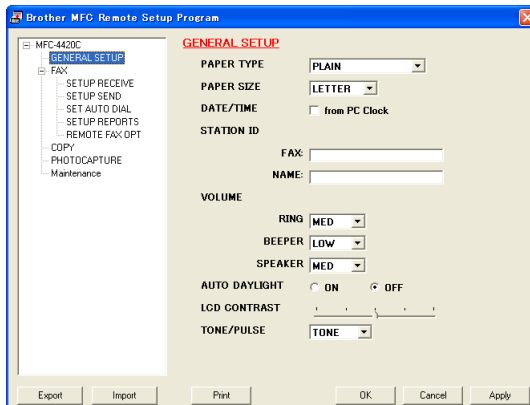

OK button

When you click **OK**, the process of uploading the data to the MFC begins. The MFC Remote Setup program is closed if an error message is displayed, enter the correct data again and then click **OK**.

Cancel button

The **Cancel** button clears your changes and exits the MFC Remote Setup application without uploading any data to the MFC.

Apply button

The **Apply** button uploads the data to the MFC, but stays in the Remote Setup application so you can make more changes.

Print button

The **Print** button prints the selected items on the MFC. You cannot print the MFC Remote Setup changes until you click the **Apply** button to upload the new data to the MFC. Then you can click the **Print** button to get an up-to-date printout.

Export button

Click the **Export** button to save your current settings to a file.

Import button

Click the **Import** button to read the settings from your saved file into the MFC Remote Setup screen.



You can use the **Export** and **Import** buttons to save and use several sets of settings for your MFC.

18 Using PC-FAX

(For Windows®)

PC-FAX sending

The Brother PC-FAX feature lets you send a file from your PC. You can create a file in any application on your PC, and then send it as a PC FAX. You can even attach a cover page note.

All you have to do is set up the receiving parties as Members or Groups in your PC FAX Address Book. Then you can use the Address Book Search feature to quickly find them to address your fax.



- PC FAX is available in Black & White only.
- If you are using Windows® XP or Windows® 2000 Professional, we recommend that you are logged on as an administrator.

Setting up user information



You can access the User Information from the FAX Sending dialog box by clicking .

(See *Sending a file as a PC-FAX using the Facsimile style* on page 18-14.)

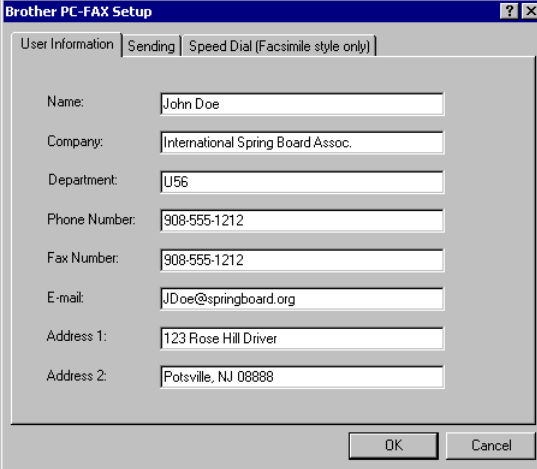

The screenshot shows the 'Brother PC-FAX Setup' dialog box with the 'User Information' tab selected. The fields are filled with the following information:

Field	Value
Name	John Doe
Company	International Spring Board Assoc.
Department	U56
Phone Number	908-555-1212
Fax Number	908-555-1212
E-mail	JDoe@springboard.org
Address 1	123 Rose Hill Driver
Address 2	Potsville, NJ 08888

Buttons: OK, Cancel

- 1 From the **Start** menu, select **Programs, Brother, Brother MFL Pro Suite**, and then select **PC-FAX Setup**. The **Brother PC-FAX Setup** dialog box will appear:
- 2 You must enter this information create the Fax Header and Cover Page.
- 3 Click **OK** to save the **User Information**.

Sending setup

From the **Brother PC-FAX Setup** dialog box, click the **Sending** tab to display the screen below.

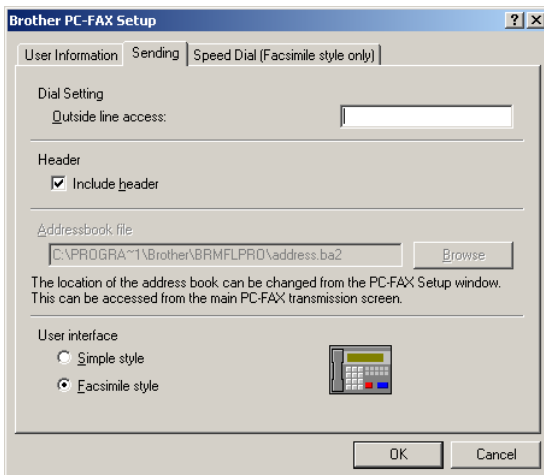

Outside line access

If you need to enter a number to access an outside line, enter it here. This is sometimes required by a local PBX telephone system (for example, if you must dial 9, to get an outside line in your office).

Include header

To add header information to the top of the fax pages you send, check the Include header box.

Address Book file

You can select more than one database file to use with the Address Book. To select you must enter the path and file name of the database file.

—OR—

Use the **Browse** button to find the database to select.

User interface

In the **Sending** tab select user interface.

You can choose the **Simple Style** or the **Facsimile Style**.

Simple style

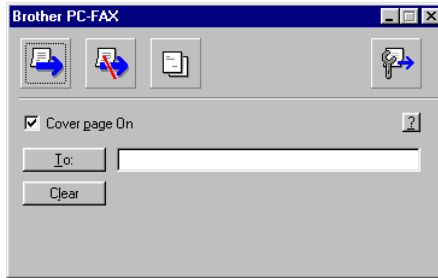

Facsimile style



Speed Dial setup

From the **Brother PC-FAX Setup** dialog box, click the **Speed Dial** tab. (To use this feature you must select the **Facsimile Style** user interface.)

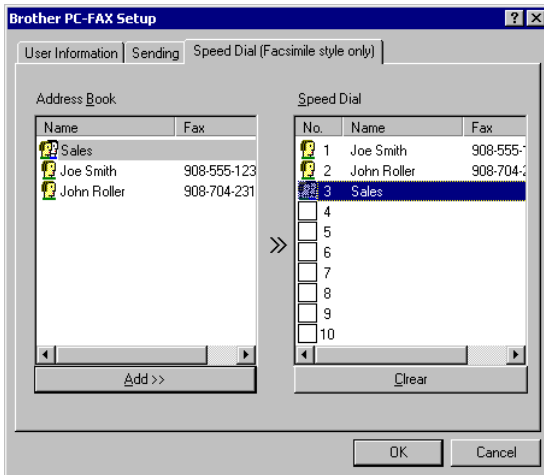

You can register a Member or Group on each of the ten Speed Dial buttons.

To register an address in a Speed Dial button:

- 1 Click the Speed Dial button you want to program.
- 2 Click the Member or Group you want to store on the Speed Dial button.
- 3 Click **Add >>** to save it.

To clear a Speed Dial button:

- 1 Click the Speed Dial button you want to clear.
- 2 Click **Clear** to erase it.

The Address Book

From the **Start** menu, select **Programs**, **Brother**, **Brother MFL Pro Suite**, and then click **Address Book**.

The **Brother Address Book** dialog box will appear:

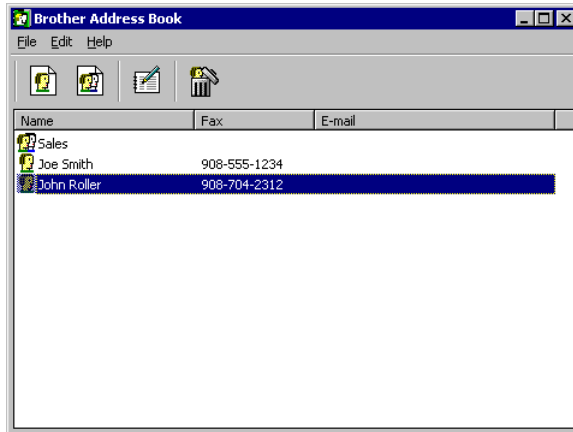



Setting up a Member in the Address Book

In the **Brother Address Book** dialog box you can add, edit and delete stored information of Members and Groups.

- 1 In the Address Book dialog box, click the  icon to add a Member.

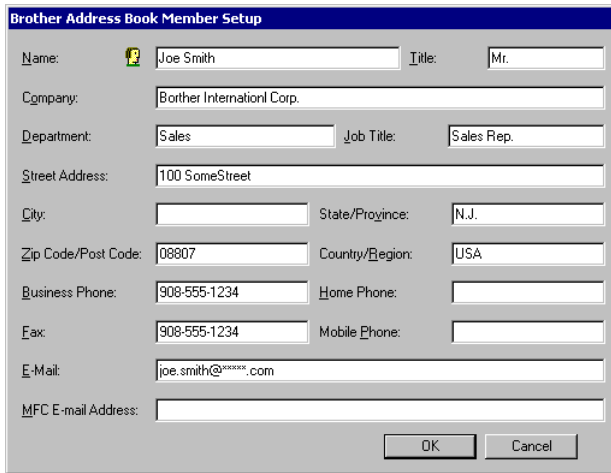
The **Brother Address Book Member Setup** dialog box will appear:



Name:	 Joe Smith	Title:	Mr.
Company:	Brother International Corp.		
Department:	Sales	Job Title:	Sales Rep.
Street Address:	100 SomeStreet		
City:		State/Province:	N.J.
Zip Code/Post Code:	08807	Country/Region:	USA
Business Phone:	908-555-1234	Home Phone:	
Fax:	908-555-1234	Mobile Phone:	
E-Mail:	joe.smith@*****.com		
MFC E-mail Address:			

OK Cancel

- 2 In the Member Setup dialog box, type the Member's information. **Name** is a required field. Click **OK** to save the information.

Setting up a Group for Broadcasting

If you often send the same PC-FAX to several Members, you can combine them in a Group.

- 1 In the **Brother Address Book** dialog box, click the  icon to create a Group.

The Group Setup dialog box appears:

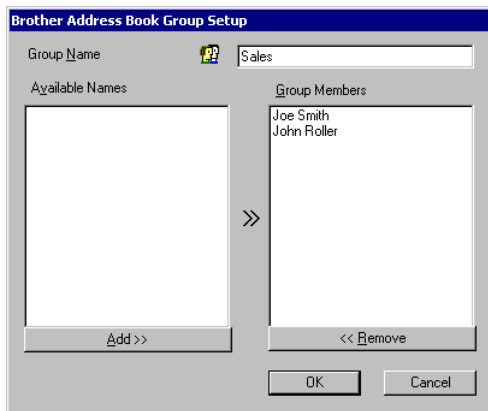

- 2 Type the name of the new Group in the **Group Name** field.
- 3 In the **Available Names** box, select each Member to be included in the Group, and then click **Add >>**. Members you add to the Group will be added to the **Group Members** box.
- 4 After all the members you want have been added, click **OK**.

Editing Member information

- 1 Select the Member or Group you want to edit.
- 2 Click the edit  icon.
- 3 Change the Member or Group information.
- 4 Click **OK** to save your changes.

Deleting a Member or Group

- 1 Select the Member or Group you want to delete.
- 2 Click the delete  icon.
- 3 When the **Confirm Item Delete** dialog box appears, click **OK**.

Exporting the Address Book

You can export the whole Address Book to an ASCII text file (*.csv). Or if you wish, you can select and create a Vcard that will be attached to that Member's outgoing E-mail. (A Vcard is an electronic business card that contains the sender's contact information.)

To export the whole current Address book:



If you are creating a Vcard, you must first select the member.

If you select Vcard in Step 1, **Save as type:** will be **Vcard (*.vcf)**.

- 1 From the Address Book select **File**, point to **Export**, and then click **Text**.
—OR—
Click **Vcard** and go to Step 5.

- 2 From the **Available Items** column, select the data fields you wish to Export and then click **Add >>**.



Select the items in the order you want them listed.

- 3 If you are exporting to an ASCII file, select the **Divide Character** - **Tab** or **Comma**. This selects between a **Tab** or **Comma** to separate the data fields.

4 Select **OK** to save the data.

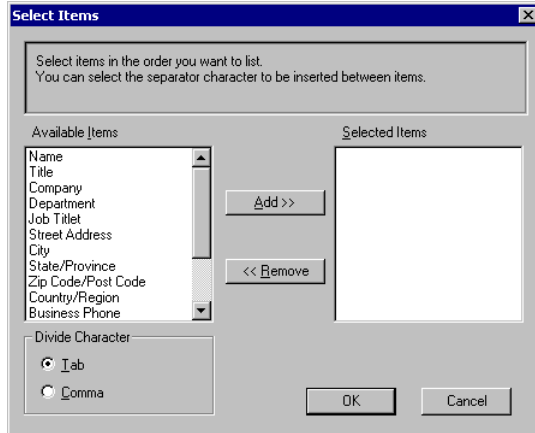

5 Type the name of the file, and then select **Save**.

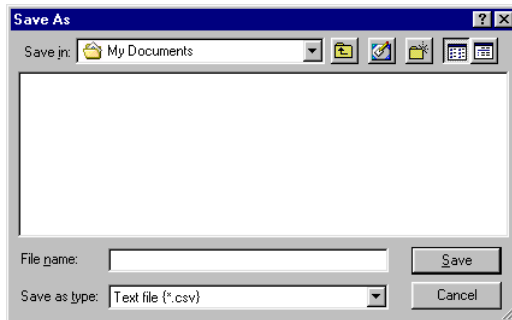



Importing to the Address Book

You can import ASCII text files (*.csv) or Vcards (electronic business cards) into your Address Book.

To import an ASCII text file:

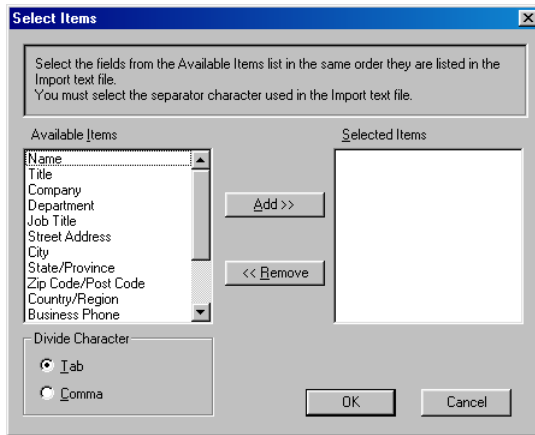
- 1 From the Address Book select **File**, point to **Import**, and then click **Text**.
—OR—
Click **Vcard** and go to Step 5.



- 2 From the **Available Items** column select the data fields you want to Import, and click **Add >>**.
-  From the Available Items list select the fields in the same order they are listed in the Import text file.
- 3 Select the **Divide Character - Tab** or **Comma** based on the file format you are importing.
- 4 To import the data click **OK**.

- 5 Type the name of the file, and then select **Open**.

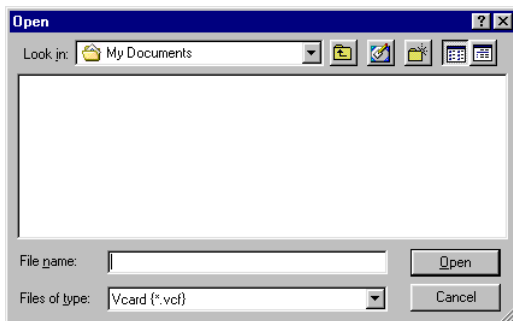

 If you selected a text file in Step 1, the **Files of type:** will be **Text file (*.csv)**.

Setting up a Cover Page

From the PC-FAX dialog box click . To access the PC-Fax Cover page setup screen. (See *Sending a file as a PC-FAX using the Facsimile style* on page 18-14.)

The **Brother PC-FAX Cover Page Setup** dialog box will appear:

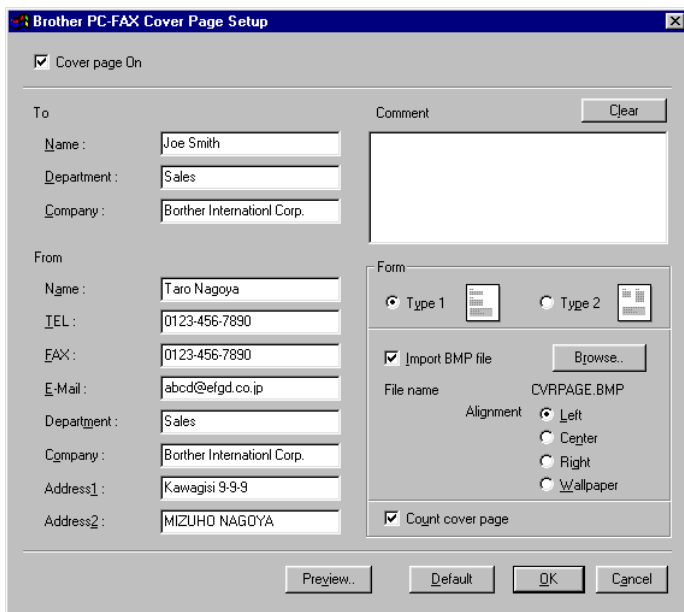

You can enter information in each field



If you are sending a fax to more than one recipient, the recipient information will not be printed on the Cover Page.

To

From

Comment

Type the comment you want to add to the cover page.

Select Cover Page Form

Select the cover page format you want to use.

Import BMP file

You can insert a bitmap file, such as your company logo, in the cover page.

Use the browse button to select the BMP file, and then select the alignment style.

Count Cover Page

When the Count Cover Page box is checked, the Cover Page will be included in the page numbering. When this box is not checked, the Cover Page will not be included.

Sending a file as a PC-FAX using the Facsimile style

- 1 Create a file in Word, Excel, Paint, Draw or any other application on your PC.
- 2 From the **File** menu, select **Print**.
The **Print** dialog box will appear:

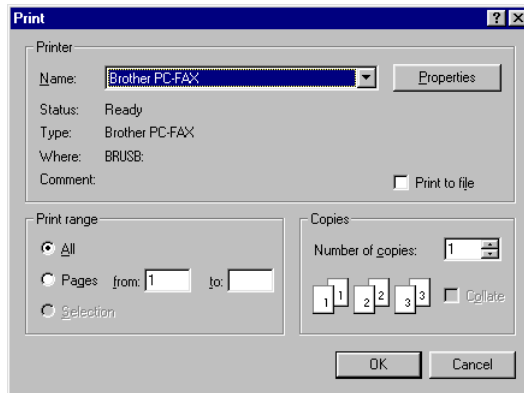



- 3 Select **Brother PC-FAX** as your printer, and then click **OK**.
The Fax Sending dialog box will appear.



- 4 Enter the fax number using any of the following methods:
 - Using the dial pad enter the number.
 - Click any of the 10 **Speed Dial** buttons.
 - Click the **Address Book** button, and then select a Member or Group from the Address Book.



If you make a mistake you can click **Clear** to delete all the entries.

- 5 To include a Cover Page, click  **Cover Page On**, and then click the Cover Page  icon to enter or edit the Cover Page information.
- 6 Click **Start** to send the fax.



If you want to cancel the fax, click **Stop**.

Redial

If you want to redial a number, click **Redial** to scroll through the last five fax numbers, and then click **Start**.

Sending a file as a PC-FAX using the Simple style

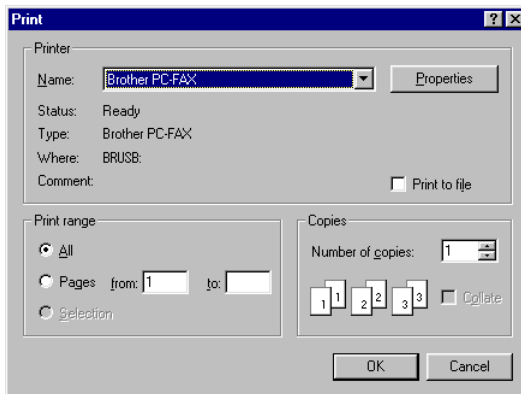

- 1 Create a file in Word, Excel, Paint, Draw or any other application on your PC.
- 2 From the **File** menu, select **Print**.
The **Print** dialog box will appear:



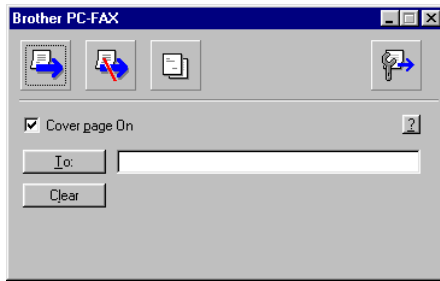

- 3 Select **Brother PC-FAX** as your printer, and then click **OK**.
The FAX Sending dialog box will appear:



- 4 In the **To:** field, type the fax number of the recipient. You can also use the Address Book to select destination fax numbers by clicking the **To:** button. If you made a mistake entering a number, click the **Clear** button to delete all the entries.
- 5 To send a Cover Page and note, click the **Cover Page On** check box.

 You can also click the  icon to create or edit a cover page.

- 6 When you are ready to send your fax, click the Send  icon.
- 7 If you wish to cancel the fax, click the Cancel  icon.

19 Using the PhotoCapture Center™ from your PC

(For Windows®)

Introduction

 For Windows® 2000 users, to access the PhotoCapture Center™ features from your PC you must first install a Windows® 2000 update. Please see the Quick Setup Guide for installation instructions.

1 Insert a SmartMedia®, CompactFlash® or Memory Stick® card into your MFC.

 If two or three media cards are inserted at the same time, the PhotoCapture Center™ will read only the card that was put in first. To have access to another card, you must first take out all the cards, and then put in the media card you wish to access.

2 In Windows® Explorer on your PC, double-click the **Removable Disk** icon. The files and folders that are on the media card will appear on your PC screen.

 If you are using Windows® XP and you create a name for the volume label of the media card, the name will appear instead of 'Removable Disk'.

3 You can edit the file and save it to another drive on your PC.

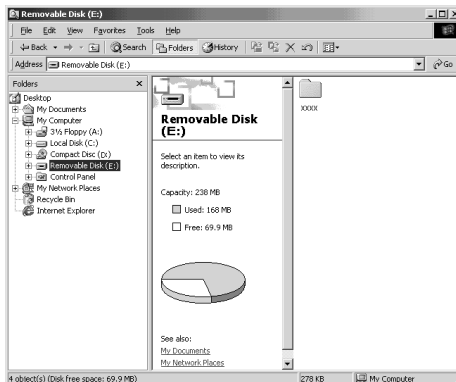

When you take out a media card, do the following to keep from damaging it:

- 1** In the My Computer window, right-click the removable disk icon and select “**Eject**” from the Context menu.
 - 2** Wait until the LED on the MFC stops blinking before taking out the media card.
-  Do **NOT** unplug the power cord, USB cable or remove a SmartMedia[®], CompactFlash[®] or Memory Stick[®] card from the MFC while it is reading the card (LED is flashing). You will lose your data or damage the card.

If you took out the media card while the LED was flashing, you must immediately restart your PC before putting the media card back in. If you put in another media card before the PC is rebooted, the data on it may be destroyed.



While the MFC is printing from the PhotoCapture Center™, the PC cannot access the PhotoCapture Center™ for any other operation.



Magic Gate Memory Stick can be used, but the music data that is stored on the stick can not be read.

Using ArcSoft® PhotoPrinter® 4

Arcsoft PhotoPrinter® 4 software is for editing and printing your images including templates that aid you in printing multiple images on one page and the ability to crop, rotate and add special effects to your picture.

Overview of basic steps

- 1 Insert the memory card (CompactFlash®, SmartMedia® or Memory Stick® Card) into the appropriate slot on your MFC.
 - 2 To start the PhotoPrinter® 4 software, double-click on the PhotoPrinter® icon on your desktop.
 - 3 Click on the **Get Photo** button.
 - 4 Click on the **Add Photo** button.
-  Add Photo enables the user to create an album using the contents of the drive. You can copy photos from the PhotoCapture Center™ to your computer.
- 5 Select the Removable Disk from the pull down list.

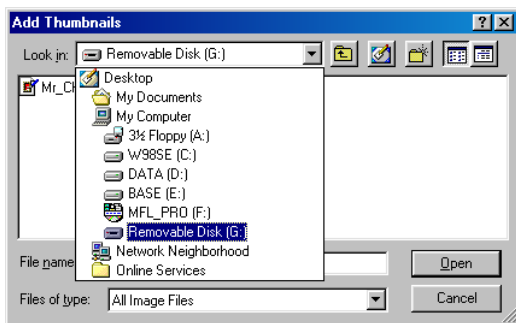

- 6 Click on the individual images that you want to create thumbnails for.
- 7 Click **Open** to generate thumbnails.

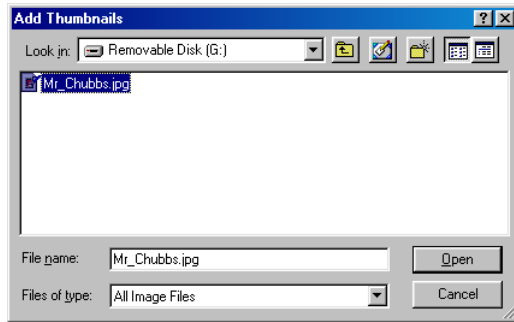

- 8 Select the thumbnail of the image you want to use, and then click **Okay**.

20 Using your MFC with a Macintosh®

Setting up your USB-equipped Apple® Macintosh® G3, G4 or iMac™ or iBook™ with Mac OS 8.6-9.2 or Mac OS X 10.1/10.2.1 or greater



Before you can connect the MFC to your Macintosh®, you must buy a USB cable that is not longer than 6 feet (1.8 metres). Do not connect the MFC to a USB port on a key board or a non-powered USB hub.

The features supported by the MFC will depend on the operating system you are using. The chart below shows which features are supported.

Feature	MAC OS		MAC OS X	
	8.6	9.X	10.1	10.2.1 or greater*2
Printing	Yes	Yes	Yes	Yes
Scanning (TWAIN)	Yes	Yes	No	Yes
PC-FAX sending	Yes	Yes	Yes	Yes
Remote Setup	No	No	Yes	Yes
PhotoCapture Center	*1	Yes	Yes	Yes

*1 You need to download USB Mass Storage Support 1.3.5 from Apple® Web site (www.apple.com).

*2 For Mac OS X 10.2 user, please upgrade to Mac OS X 10.2.1 or greater. (The latest information for Mac OS X, please visit at: <http://solutions.brother.com>)

Using the Brother printer driver with your Apple® Macintosh® (OS 8.6-9.2)

To select a Printer:

- 1 Open the **Chooser** from the Apple menu.

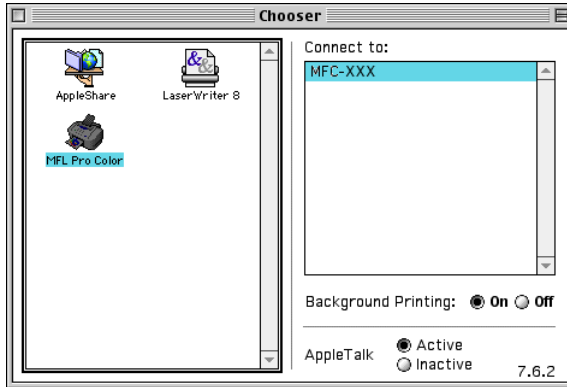

- 2 Click the **MFL Pro Color** icon. On the right side of the **Chooser** window, click the printer you want to print to. Close the **Chooser**.

To print a document:

- From the application software such as PaperPort®, click **File** menu and select **Page Setup**. You can change the settings for **Paper Size**, **Paper Thickness**, **Paper Source**, **Orientation**, and **Scaling** and then click **OK**.

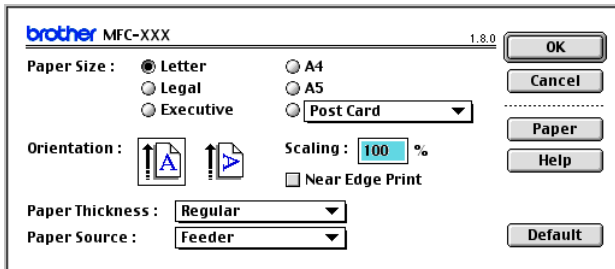

- From application software such as PaperPort, click **File** menu and select **Print**. Click **Print** to start printing.

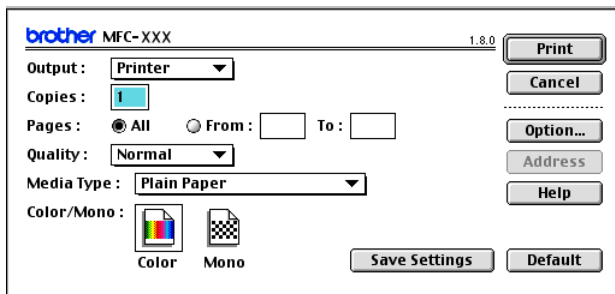

-  If you want to change **Copies**, **Pages**, **Quality**, **Media Type** and **Color/Mono**, select your settings before clicking **Print**. Click the **Option** button to change **Document** and **Printing Options**.

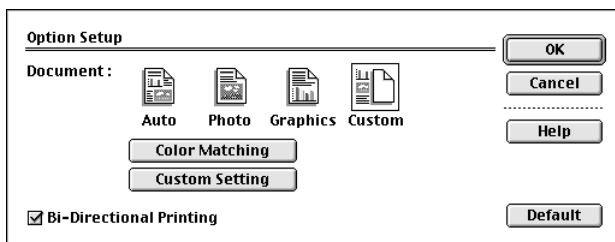

Using the Brother Printer Driver with Your Apple® Macintosh® (OS X 10.1/10.2.1 or greater)

Choosing page setup options

From application software such as TextEdit, click the **File** menu and select **Page Setup**. Make sure *MFC-4420C* is selected in the **Format for** pop-up menu. You can change the settings for **Paper Size**, **Orientation** and **Scaling**, then click **OK**.

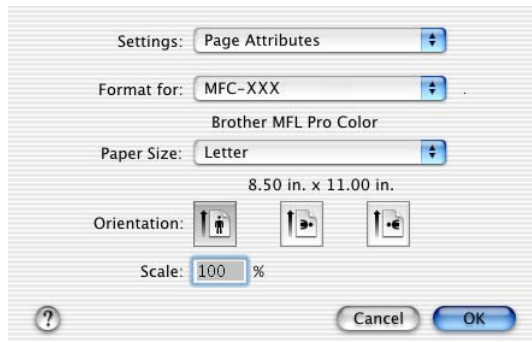

Printing a document

From application software such as TextEdit, click the **File** menu and select **Print**. The print dialog box appears, click **Print**.

Make sure *MFC-4420C* is selected in the **Printer** pop-up menu. You can select the number of copies or a range of pages to print.

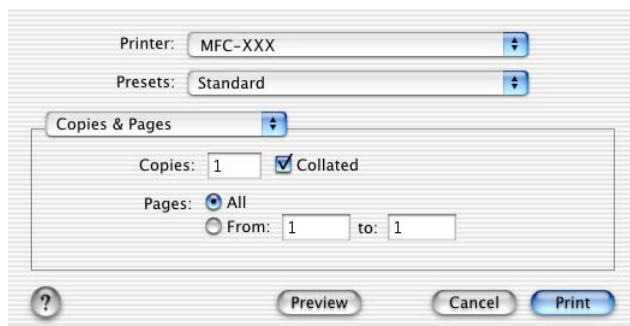

Choosing printing options

To control special printing features of the printer, choose **Print Settings** in the Print dialog box. You can change **Quality**, **Media Type**, **Color/Mono** and **Bi-Directional Printing** settings.

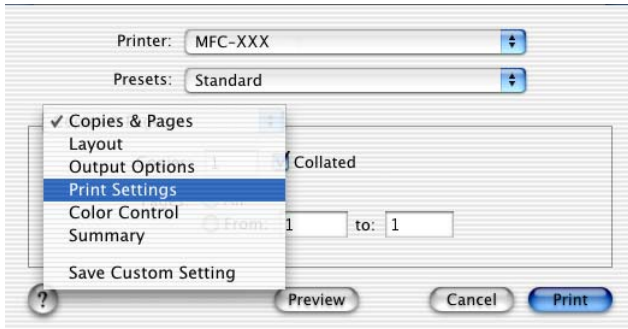

Sending a fax from your Macintosh[®] application

You can send a fax directly from a Macintosh[®] application by doing the following:

- 1 Create a document in a Macintosh application.
- 2 To send a fax, select **Print** from the **File** menu.
The Printer dialog box will appear:

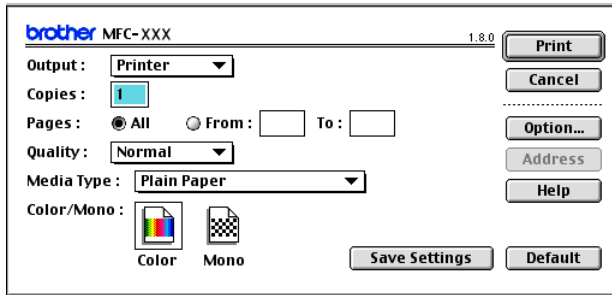

When *Printer* is selected, the top button shows **Print** and the **Address** button is grayed.

- 3 From the **Output** pull-down menu, select *Facsimile*.

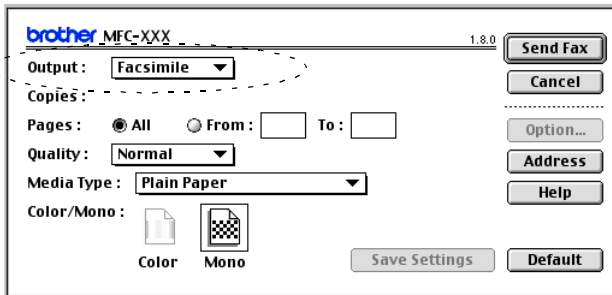

When *Facsimile* is selected, the top button changes to **Send Fax** and the **Address** button will be available.

- 4 Click **Send Fax**.
The **Send Fax** dialog box appears:

The screenshot shows a dialog box titled "Send Fax". At the top left is the label "Send Fax". Below it is the "Input Fax Number:" label followed by an empty text box. To the right is the "Destination Fax Numbers:" label followed by an empty list box. Below the input field is the "Stored Fax Numbers:" label. This section contains a list with two columns: names and phone numbers. The list items are: Barbie (908-477-8888), Bob (908-869-8888), Frank (908-236-8888), and Tony (908-569-8888). Between the "Stored Fax Numbers" list and the "Destination Fax Numbers" list are two buttons: ">>" and "<<". At the bottom of the dialog box are seven buttons: "New", "Group", "Edit", "Delete", "Save", "Cancel", and "Send Fax".

The **Send Fax** dialog box has two list boxes. The left box shows all the previously **Stored Fax Numbers** and the right box shows the **Destination Fax Numbers** as you select them.

- 5 To address the fax, type a fax number in the **Input Fax Number** box.

—OR—

Select a name or number from the **Stored Fax Numbers** box, and then click . The name or number of the person you are sending the fax to will appear in the **Destination Fax Numbers** box.



You can select several stored numbers at once by using the Shift and Ctrl keys.

- 6 If you want, you can add your new members to the **Stored Fax Number** at this time by clicking **New** to open the address book. (See *Setting up your Address Book* on page 20-8.)

—OR—

You can add a new Group by clicking **Group** to open the address book. (See *Adding a new Group* on page 20-9.)

7 When you are finished addressing your fax, click **Send Fax**.

 To select and only send certain pages of the document, click **OK** to go to the Print dialog box.

 If you click **Send Fax** without addressing your fax, the following error message will appear:

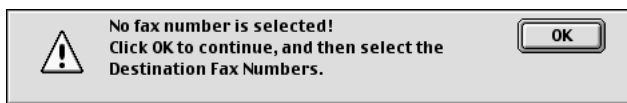

Click **OK** to go to the **Send Fax** dialog box.

Setting up your Address Book

You can add new Members and Groups to your Address Book, while you are addressing a fax.

Adding a new Member

1 To add a new Member to the **Address Book**, in the Facsimile dialog box click **Address**.

The **Address Book** dialog box will appear:

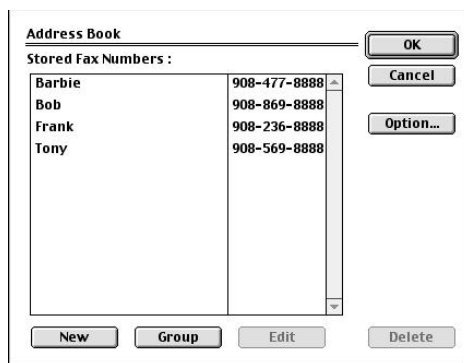

- 2 Click **New**. The following dialog box will appear:

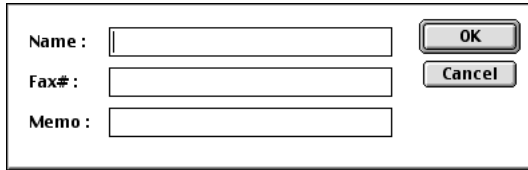

Name :

Fax# :

Memo :

OK

Cancel

- 3 Type the name and fax number.
- 4 You can store a comment in the Memo field (up to 15 characters).
- 5 Click **OK** to go back to the **Address Book** dialog box.

Adding a new Group

You can set up a Group of people that you send the same fax to.

- 1 Click **Group**.
The **Group Setting** dialog box will appear.

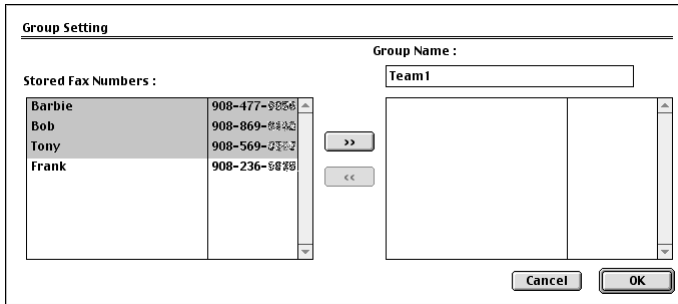

Group Setting

Group Name :

Stored Fax Numbers :

Barbie	908-477-9856
Bob	908-869-8432
Tony	908-569-2322
Frank	908-236-5888

>>

<<

Cancel OK

- 2 In the **Group Name** field, type a name for your Group.
- 3 In the **Stored Fax Numbers** box select the people for your Group. Click.
The selected people will appear in the box under the **Group Name** field.

- 4 Click **OK** to go back to the **Address Book** dialog box.

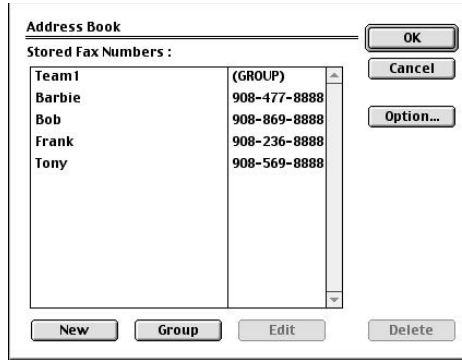

- 5 Click **OK** to go back to the Print/Facsimile dialog box.

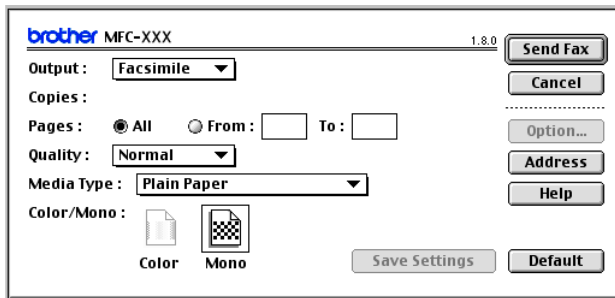

- 6 Then if you are ready to send your fax, click **Send Fax**.

Using the Brother TWAIN scanner driver with your Macintosh® (For Mac OS 8.6-9.2 and OS X 10.2.1 or greater)

The Brother MFC software includes a TWAIN Scanner driver for Macintosh®. You can use this Macintosh® TWAIN Scanner driver with any applications that support the TWAIN specifications.

Accessing the scanner

Run your Macintosh® TWAIN-compliant application software. The first time you use the Brother TWAIN driver (MFL Pro/P2500), set it as the default by choosing **Select Source** (or the other menu name to select the device). Afterwards, for each document you scan choose **Acquire Image** or **Scan**. The scanner setup dialog box will appear.

 The screen shown in this section are from Mac OS 9. The screen on your Macintosh® may vary depending on your Operating System.

 The method of selecting the source or choosing to scan may vary depending on the application software you are using.

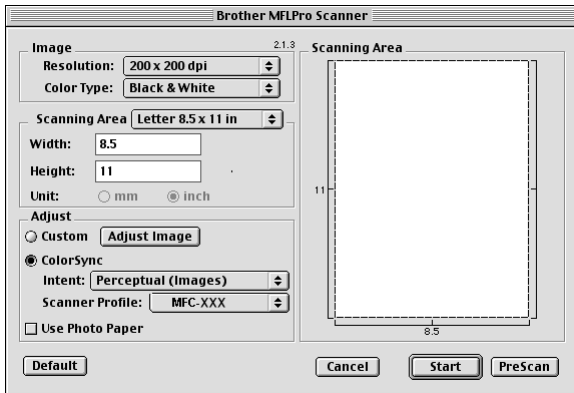

(OS 8.6–9.2)



If you are using PaperPort® 5.5 for Mac, from the ScanSoft menu (located below the ScanSoft icon on the Macintosh desktop menu bar), choose **Acquire Image**. For details about the ScanSoft menu selections, please refer to the PaperPort® Documentation located in the PaperPort® 5.5 Folder/User Docs/Splashug.pdf file.

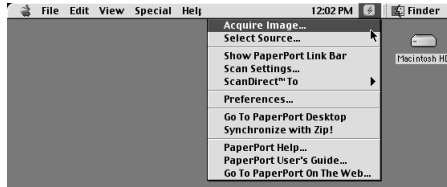

Scanning an image into your Macintosh®

You can scan a whole page

—OR—

scan a portion after prescanning the document.

Scanning a whole page

- 1 Place the original face down on the scanner glass.
- 2 Adjust the following settings, if needed, in the Scanner Setup dialog box:

Resolution

Color Type

Scanning Area

Brightness

Contrast

Color Sync

- 3 Click **Start**.

When scanning has finished, the image will appear in your graphics application.

PreScanning an image

PreScanning allows you to scan an image quickly at a low resolution. A thumbnail version will appear in the **Scanning Area**. This is only a preview of the image, so you can see how it will look. The **PreScan** button will allow you to crop unwanted areas from the images. When you are satisfied with the preview, click **Start** to scan the image.

- 1 Insert the original face down on the scanner glass.
- 2 Click **PreScan**.
The whole image will be scanned into your Macintosh® and will appear in the **Scanning Area** of the Scanner dialog box:
- 3 To scan a portion of the prescanned image, click and drag the mouse to crop it.

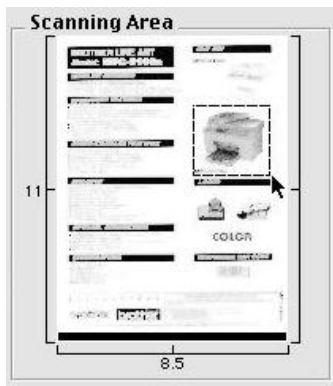

- 4 Make your adjustments to the settings for **Resolution**, **Color Type** (Gray Scale), **Brightness**, **Contrast**, and Size in the Scanner Setup dialog box.
- 5 Click **Start**.
This time only the cropped area of the original will appear in the Scanning Area.
- 6 In your editing software, you can refine the image.

Settings in the Scanner window

Image

Resolution

From the **Resolution** pop-up menu choose the scanning resolution. Higher resolutions use more memory and transfer time, but produce a finer scanned image.

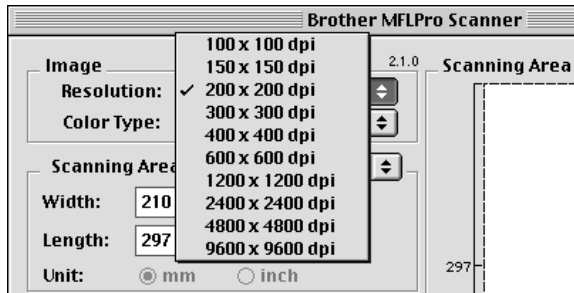

Color Type

Black & White—Set the image Type to *Black and White* for text or line art. For photographic images, set the image type to Gray (Error diffusion) or True Gray.

Gray (Error Diffusion)—is used for documents with photographic images or graphics. (Error Diffusion is a method for creating simulated gray images by placing black dots instead of the true gray dots in a specific matrix instead of true gray dots.)

True Gray—is used for documents with photographic images or graphics. This mode is more exact because it uses up to 256 shades of gray. It requires the most memory and takes the longest transfer time.

Colors—Choose either 256 Color, which scans up to 256 colors or 24-bit color which scans up to 16.8 million colors. Although using 24-bit color creates an image with the most accurate colors, the image file will be about three times larger than a file created with 256 Color.

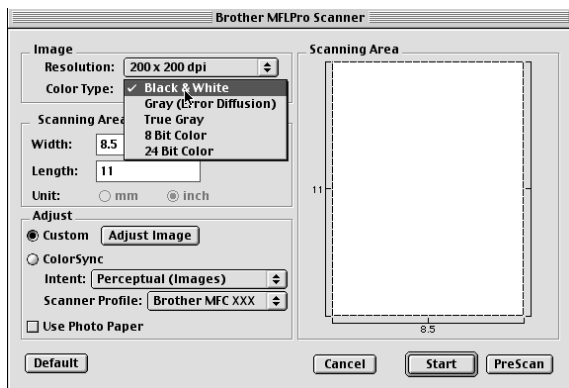

Scanning Area

Set the **Size** to one of the following:

- *Letter (8.5 × 11 inches)*
- *A4 (210 × 297 mm)*
- *A5 (148 × 210 mm)*
- *B5 (182 × 257 mm)*
- *Executive (7.25 × 10.5 inches)*
- *Business Card (90 × 60 mm)*
- *Custom (adjusts it from 0.35 × 0.35 inches to 8.5 × 11.69 inches)*

After you choose a custom size, you can adjust the scanning area. Click and hold the mouse button as you drag the mouse to crop the image.

Width: Enter the width of the custom size.

Length: Enter the length of the custom size.

Business Card Size

To scan business cards, select the Business Card size (90 × 60 mm) and place the business card at the center of scanner glass.

When you are scanning photographs or other images to use in a word processor or other graphics application, it is a good idea to try different settings for the Contrast, Mode and Resolution to determine which settings look the best.

Adjusting the Image

Brightness

Adjust the **Brightness** setting to get the best image. The Brother TWAIN Scanner driver offers 100 Brightness levels (-50 to 50). The default value is 0, representing an 'average' setting.

You can set the **Brightness** level by dragging the slide bar to the right to lighten the image or to the left to darken the image. You can also type a value in the box to set the level. Click **OK**.

If the scanned image is too light, set a lower Brightness level and scan the image again.

If the image is too dark, set a higher Brightness level and scan the image again.

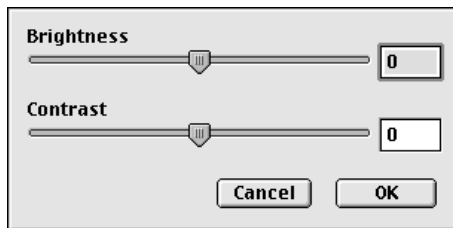

Contrast

You can only adjust the **Contrast** level when you have selected one of the Gray Scale settings, it is not available when you have selected Black & White is selected as the Color Type.

Increasing the **Contrast** level (by dragging the slide bar to the right) emphasizes dark and light areas of the image, while reducing the **Contrast** level (by dragging the slide bar to the left) reveals more detail in the gray areas. Instead of using the slide bar, you can type a value in the box to set the Contrast. Click **OK**.

Color Sync Dialog

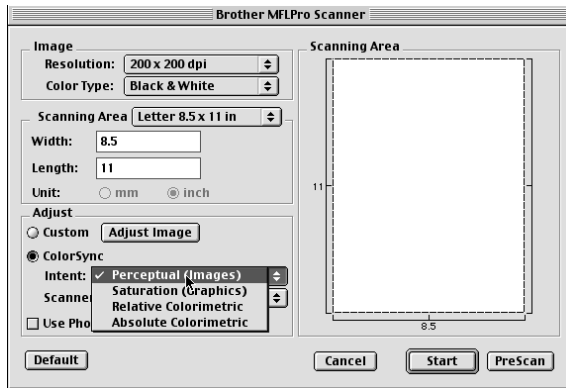

Perceptual Matching—All the colors of a given gamut are scaled proportionally to fit within another gamut. The purpose is to keep maintains the balance between the colors of the image. This is the best way to get realistic images, for photographs and other realistic graphics.

Saturation Matching—The relative saturation of colors is maintained from gamut to gamut. So basically the colors are shifted to the edge of the gamut to get the most saturated color possible. Rendering the image using this intent gives the strongest colors and is the best choice for bar graphs and pie charts, in which the actual color displayed is less important than its vividness.

Relative Colorimetric Matching—The colors that fall within the gamuts of both devices are left unchanged. Some colors in both images will be exactly the same, a useful outcome when colors must match quantitatively. What that means is that if the color is inside the gamut, it will stay the same color. However, if the color is outside the gamut, it will be mapped to the edge of the gamut. This intent is best suited for logos or “spot colors” where color must match.

Absolute Colorimetric Matching—A close appearance match may be achieved over most of the tonal range, but if the minimum density of the idealized image is different from that of the output image, the areas of the image that are left blank will be different. Colors that fall within the gamuts of both devices are left unchanged.

Scanner Profile

Select your Brother MFC.

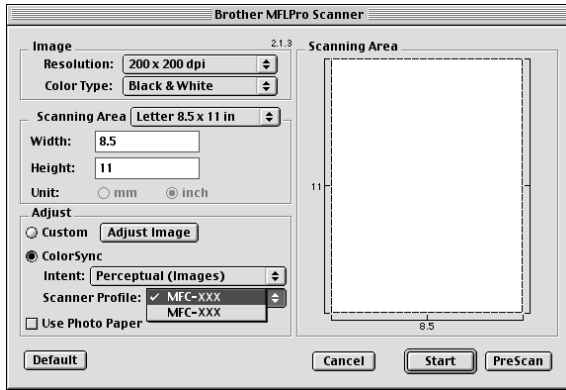

MFC Remote Setup (Mac OS 10.1/10.2.1 or greater)

The MFC Remote Setup application allows you to quickly set up your MFC by taking advantage of the ease and speed of programming on your Macintosh®. When you access this application, the settings on your MFC will be downloaded automatically to your Macintosh® and displayed on your computer screen. If you change the settings, you can upload them directly to the MFC.



The 'MFC Remote Setup' application icon is in Macintosh HD/Library/Printers/Brother/Utility.

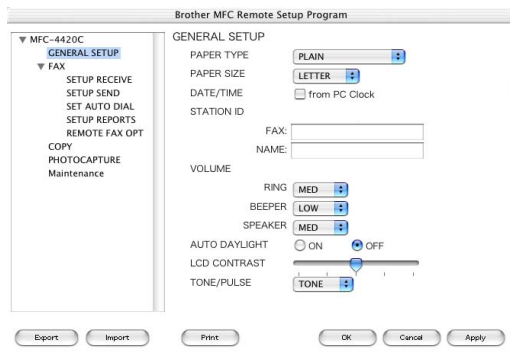

OK

This starts the process of uploading the data to the MFC and exiting the remote setup program. If an error message is displayed enter the correct data again. Click **OK**.

Cancel

This exits the remote setup application without uploading the data to the MFC.

Apply

This uploads the data to the MFC, but does not exit the remote setup application.

Print

This command prints the selected items on the MFC. You can not print the data until it is uploaded to the MFC. Click **Apply** to upload the new data to the MFC and click **Print**.

Export

This command saves the current configuration settings to a file.

Import

This command reads the settings from a file.

Using the PhotoCapture Center™ from a Macintosh®

You can access the Media Card inserted into the MFC from a Macintosh®.



For Mac OS 8.6 only

You have to download “USB Mass Storage Support 1.3.5” software from the web site of Apple® Macintosh®.

- 1 Insert a SmartMedia®, CompactFlash® or Memory Stick® card into your MFC. The removal disk icon will appear on the Desktop.



If you create a name for the volume level of the media card, the name will appear instead of “Removable Disk”.

- 2 Double-click the Removable Disk icon. The files and folders that are on the media card will be displayed on your screen.
- 3 You can edit the file and save it to another drive on your Macintosh®.

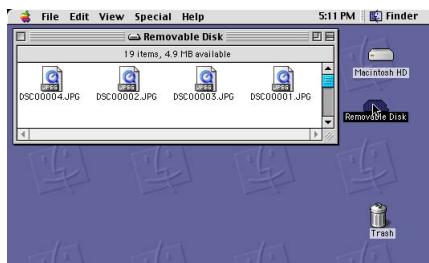

- 4 Quit all running applications that are stored on the media card and drag the removal disk icon onto Trash before you remove the media card from the MFC.



The Photo Capture Center™ will only read one card at a time so do not insert more than one media card at a time.



Do NOT unplug the power cord, USB cable or remove a SmartMedia®, CompactFlash® or Memory Stick® card from the MFC while it is reading the card (LED is flashing). You will lose your data or damage the card.



While the MFC is printing from the PhotoCapture Center™, the Macintosh® cannot access the PhotoCapture Center™ for another operation.



Magic Gate Memory Stick can be used, but the music data that is stored on the stick can not be read.

Using ArcSoft® PhotoPrinter® 4

Arcsoft PhotoPrinter® 4 software is for editing and printing your images including templates that aid you in printing multiple images on one page and the ability to crop, rotate and add special effects to your picture.

Overview of basic steps

- 1 Insert the memory card (CompactFlash®, SmartMedia® or Memory Stick® Card) into the appropriate slot on your MFC.
 - 2 To start the PhotoPrinter® 4 software, double-click on the PhotoPrinter® icon on your desktop.
 - 3 Click on the **Get Photo** button.
 - 4 Click on the **Add Photo** button.
-  Add Photo enables the user to create an album using the contents of the drive. You can copy photos from the PhotoCapture Center™ to your computer.
- 5 Select the Volume name from the **Open** dialog.

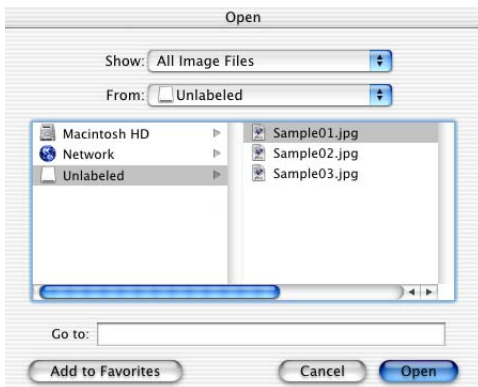

(from Mac OS 10.2.1)

6 Select the image file and click **Open**.

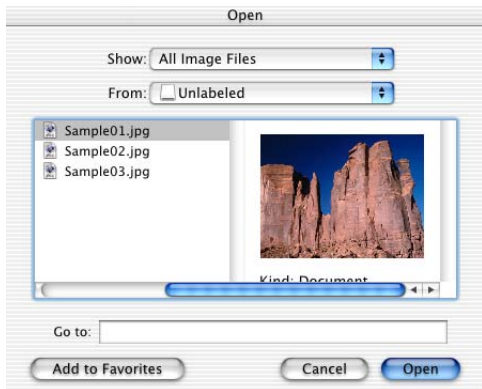

(from Mac OS 10.2.1)

21 Important information

Standard telephone and FCC Notices

These notices are in effect on models sold and used in the United States only.

When programming emergency numbers or making test calls to emergency numbers:

- Remain on the line and briefly explain to the dispatcher the reason for the call before hanging up.
- Perform these activities in the off-peak hours, such as early morning or late evening.

This equipment complies with Part 68 of the FCC rules and the requirements adopted by the ACTA. On the backside of this equipment is a label that contains, among other information, a product identifier in the format US: AAAEQ##TXXXX. If requested, this number must be provided to the telephone company.

You may safely connect this equipment to the telephone line by means of a standard modular jack, USOC RJ11C.

A plug and jack used to connect this equipment to the premises wiring and telephone network must comply with the applicable FCC Part 68 rules and requirements adopted by the ACTA. A compliant telephone cord and modular plug is provided with this product. It is designed to be connected to a compatible modular jack that is also compliant. See installation instructions for details.

The REN is used to determine the number of devices that may be connected to a telephone line. Excessive RENs on a telephone line may result in the devices not ringing in response to an incoming call. In most but not all areas, the sum of RENs should not exceed five (5.0). To be certain of the number of devices that may be connected to a line, as determined by the total RENs, contact the local telephone company. For products approved after July 23, 2001, the REN for this product is part of the product identifier that has the format US:AAAEQ##TXXXX. The digits represented by ## are the REN without a decimal point (e.g., 06 is a REN of 0.6). For earlier products, the REN is separately shown on the label.

If this equipment causes harm to the telephone network, the telephone company will notify you in advance that temporary discontinuance of service may be required. But if advance notice isn't practical, the telephone company will notify the customer as soon as possible. Also, you will be advised of your right to file a complaint with the FCC if you believe it is necessary.

The telephone company may make changes in its facilities, equipment, operations or procedures that could affect the operation of the equipment. If this happens the telephone company will provide advance notice in order for you to make necessary modifications to maintain uninterrupted service.

If trouble is experienced with this equipment, for repair or warranty information, please contact Brother Customer Service. (See *Brother numbers* on page i.) If the equipment is causing harm to the telephone network, the telephone company may request that you disconnect the equipment until the problem is resolved.

Connection to party line service is subject to state tariffs. Contact the state public utility commission, public service commission or corporation commission for information.

If your home has specially wired alarm equipment connected to the telephone line, ensure the installation of this equipment does not disable your alarm equipment. If you have questions about what will disable alarm equipment, call your telephone company or a qualified installer.

If you are not able to solve a problem with your MFC, call Brother Customer Service. (See *Brother numbers* on page i.)

WARNING

For protection against the risk of electrical shock, always disconnect all cables from the wall outlet before servicing, modifying or installing the equipment.

This equipment may not be used on coin service lines provided by the telephone company or connected to party lines.

Brother cannot accept any financial or other responsibilities that may be the result of your use of this information, including direct, special or consequential damages. There are no warranties extended or granted by this document.

WARNING

Important—About the interface cable

This machine has been certified to comply with FCC standards, which are applied to the USA only. A grounded plug should be plugged into a grounded AC outlet after checking the rating of the local power supply for the printer to operate properly and safely.

Federal Communications Commission (FCC) Declaration of Conformity (USA only)

Responsible Party: Brother International Corporation
100 Somerset Corporate Boulevard
Bridgewater, NJ 08807-0911 USA
TEL: (908) 704-1700

declares, that the products

Product Name: MFC-4420C

comply with Part 15 of the FCC Rules. Operation is subject to the following two conditions: (1) This device may not cause harmful interference, and (2) this device must accept any interference received, including interference that may cause undesired operation.

This equipment has been tested and found to comply with the limits for a Class B digital device, pursuant to Part 15 of the FCC Rules. These limits are designed to provide reasonable protection against harmful interference in a residential installation. This equipment generates, uses, and can radiate radio frequency energy and, if not installed and used in accordance with the instructions, may cause harmful interference to radio communications. However, there is no guarantee that interference will not occur in a particular installation. If this equipment does cause harmful interference to radio or television reception, which can be determined by turning the equipment off and on, the user is encouraged to try to correct the interference by one or more of the following measures:

- Reorient or relocate the receiving antenna.
- Increase the separation between the equipment and receiver.

- Connect the equipment into an outlet on a circuit different from that to which the receiver is connected.
- Call the dealer or an experienced radio/TV technician for help.

Important

Changes or modifications not expressly approved by Brother Industries, Ltd. could void the user's authority to operate the equipment.

Industry Canada Compliance Statement (Canada only)

This Class B digital apparatus complies with Canadian ICES-003.

Cet appareil numérique de la classe B est conforme la norme NMB-003 du Canada.

International ENERGY STAR® Compliance Statement

As an ENERGY STAR® Partner, Brother Industries, Ltd. has determined that product meets the ENERGY STAR® guidelines for energy efficiency.



Important safety instructions

- 1** Read all of these instructions.
- 2** Save them for later reference.
- 3** Follow all warnings and instructions marked on the product.
- 4** Unplug this product from the wall outlet before cleaning. Do not use liquid or aerosol cleaners. Use a damp cloth for cleaning.
- 5** Do not use this product near water.
- 6** Do not place this product on an unstable cart, stand, or table. The product may fall, causing serious damage to the product.
- 7** Slots and openings in the cabinet and the back or bottom are provided for ventilation; to ensure reliable operation of the product and to protect it from overheating, these openings must not be blocked or covered. The openings should never be blocked by placing the product on a bed, sofa, rug, or other similar surface. This product should never be placed near or over a radiator or heater. This product should never be placed in a built-in installation unless proper ventilation is provided.
- 8** This product should be operated from the type of power source indicated on the label. If you are not sure of the type of power available, call your dealer or local power company.
- 9** This product is equipped with a 3-wire grounding type plug, a plug having a third (grounding) pin. This plug will fit into only a grounding-type power outlet. This is a safety feature. If you are unable to insert the plug into the outlet, call your electrician to replace your obsolete outlet. Do not defeat the purpose of the grounding-type plug.
- 10** Do not allow anything to rest on the power cord. Do not place this product where people can walk on the cord.
- 11** If an extension cord is used with this product, make sure that the total ampere ratings on the products plugged into the extension cord do not exceed the extension cord ampere rating. Also, make sure that the total of all products plugged into the wall outlet does not exceed 15 amperes (USA only).
- 12** Do not place anything in front of the MFC that will block received faxes. Do not place anything in the path of received faxes.

- 13** Wait until pages have exited the MFC before picking them up.
- 14** Never push objects of any kind into this product through cabinet slots, since they may touch dangerous voltage points or short out parts resulting in the risk of fire or electric shock. Never spill liquid of any kind on the product.
- 15** Do not attempt to service this product yourself, as opening or removing covers may expose you to dangerous voltage points and/or other risks, and may void your warranty. Refer all servicing to Authorized Service Personnel. A list of Authorized Service Centers has been included for your convenience, or you may contact Brother Customer Service for your nearest Brother Authorized Service Center. (See *Brother numbers* on page i.)
- 16** Unplug this product from the wall outlet and refer servicing to Authorized Service Personnel under the following conditions:
 - When the power cord is damaged or frayed.
 - If liquid has been spilled into the product.
 - If the product has been exposed to rain or water.
 - If the product does not operate normally when the operating instructions are followed. Adjust only those controls that are covered by the operating instructions. Improper adjustment of other controls may result in damage and will often require extensive work by a qualified technician to restore the product to normal operation.
 - If the product has been dropped or the cabinet has been damaged.
 - If the product exhibits a distinct change in performance, indicating a need for service.
- 17** To protect your product against power surges, we recommend the use of a power protection device (Surge Protector).

Trademarks

The Brother logo is a registered trademark of Brother Industries, Ltd.

Brother is a registered trademark of Brother Industries, Ltd.

PhotoCapture Center is a trademark of Brother International Corporation.

Multi-Function Link and True2Life are registered trademarks of Brother International Corporation.

© Copyright 2003 Brother Industries, Ltd. All rights reserved.

Windows and Microsoft are registered trademarks of Microsoft in the U.S. and other countries.

Macintosh is a registered trademark of Apple Computer, Inc.

PaperPort and TextBridge are registered trademarks of ScanSoft, Inc.

PhotoPrinter 4 is a registered trademark of ArcSoft.

Microdrive is a trademark of International Business Machine Corporation.

SmartMedia is a registered trademark of Toshiba Corporation.

CompactFlash is a registered trademark of SanDisk Corporation.

Memory Stick is a registered trademark of Sony Corporation.

MagicGate is a trademark of Sony Corporation.

Each company whose software title is mentioned in this manual has a Software License Agreement specific to its proprietary programs.

All other brand and product names mentioned in this manual are registered trademarks of their respective companies.

22 Troubleshooting and routine maintenance

Troubleshooting

IMPORTANT

For technical help, you must call the country where you bought the MFC. Calls must be made **from within** that country.

Error Messages

As with any sophisticated office product, errors may occur. If this happens, your MFC identifies the problem and displays an error message. The most common error messages are shown below.

You can correct most problems by yourself. If you need additional help, call the Brother fax back system (USA only).

In USA only: 1-800-521-2846

ERROR MESSAGES		
ERROR MESSAGE	CAUSE	ACTION
CHECK CARTRIDGE	An ink cartridge is not properly installed.	Take out the ink cartridge and put it in again seating it properly. (See <i>Replacing the ink cartridges</i> on page 22-18.)
CHECK PAPER SIZE	Paper is not the correct size.	Reload the correct size of paper (Letter, Legal or A4), and then press Fax Start .
CHECK PAPER	The MFC is out of paper.	Add paper, and then press Fax Start .
COMM. ERROR	Poor phone line quality caused a communication error.	Try the call again. If the problem continues, call the telephone company and ask them to check your phone line.
CONNECTION FAIL	You tried to poll a fax machine that is not in Polled Waiting mode.	Check the other fax machine's polling setup.
COVER OPEN	The scanner cover is not closed completely.	Pull the Scanner Cover Release Lever and lift the scanner cover and then close it again.
DISCONNECTED	The other person or other person's fax machine stopped the call.	Try to send or receive again.

ERROR MESSAGES		
ERROR MESSAGE	CAUSE	ACTION
DATA REMAINS	Print data remains in the MFC's memory because the computer is hung up.	Re-start printing from your computer.
	Print data remains in the MFC's memory. The USB cable was unplugged while the computer was sending the data to the MFC.	Press Stop/Exit . The MFC will cancel the job and eject the page that is being printed.
DR MODE IN USE	The MFC is set to Distinctive Ring mode. You can not change the Receive Mode from Manual to another mode.	Set Distinctive Ring to OFF. (See <i>Turning off the Distinctive Ring</i> on page 5-11.)
HIGH TEMPERATURE	The print heads are too warm.	Allow the MFC to cool down.
INK EMPTY	One or more of the ink cartridges is empty. The MFC will stop all print operations. While memory is available, black and white faxes will be received into memory. If a sending machine has a color fax, the MFC's 'handshake' will request that the fax be sent as black and white. If the sending machine has the ability to convert it, the color fax will be received into memory as a black and white fax.	Replace the ink cartridges. (See <i>Replacing the ink cartridges</i> on page 22-18.)
LOW TEMPERATURE	The print heads are too cold.	Allow the MFC to warm up.
MACHINE ERROR XX	The MFC has a mechanical problem.	Call Brother Customer Service. In USA: 1-800-284-4329 In Canada: 1-877-BROTHER In Montreal: (514) 685-6464
MEDIA ERROR	The media card is either bad or not formatted.	Reinsert the correct media card.
NEAR EMPTY	One or more of the ink cartridges are running out of ink. If a sending machine has a color fax, the MFC's 'handshake' will request that the fax be sent as black and white. If the sending machine has the ability to convert it, the color fax will be received into memory as a black and white fax.	Order a new ink cartridge. (See <i>Ordering accessories and supplies</i> on page ii.)
NO FILE	The media card in the media drive does not contain a .JPG file.	Reinsert the correct media card.
NO RESPONSE/ BUSY	The number you dialed does not answer or is busy.	Verify the number and try again.
NOT REGISTERED	You tried to access a Speed Dial number that is not programmed.	Set up the Speed Dial number. (See <i>Storing Speed Dial numbers</i> on page 7-1.)
OUT OF MEMORY	The data is too large for the MFC's memory.	(See <i>Out of memory message</i> on page 10-3.)
PAPER JAM	The paper is jammed in the MFC.	(See <i>Printer Jam or Paper Jam</i> on page 22-3.)
UNSUPPORTED CARD	You inserted a media card that can not be used.	Reinsert the correct media card.

Printer Jam or Paper Jam

Remove the jammed paper depending on where it is jammed in the MFC.

Paper is jammed in the paper tray.

- 1 Push the lever as shown below, and remove the jammed paper.

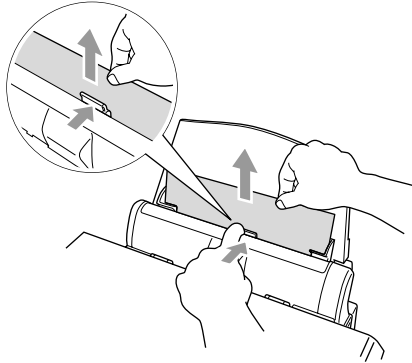

Paper is jammed inside the paper tray.

- 1 Remove any paper from the paper tray that is not jammed.

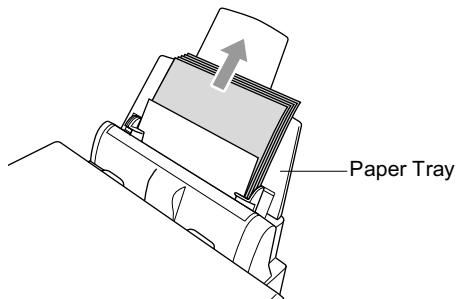

- 2** Pull the paper tray out of the MFC.

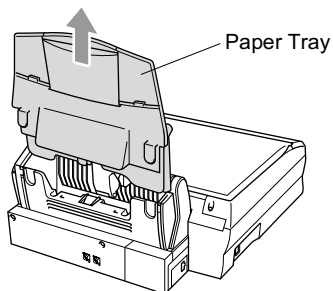

- 3** Pull up the jammed paper to remove it.

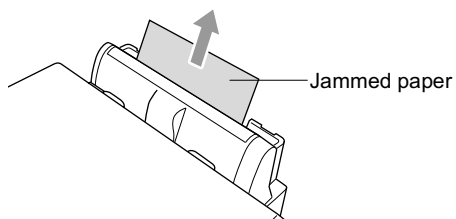

- 4** Reinstall the paper tray.

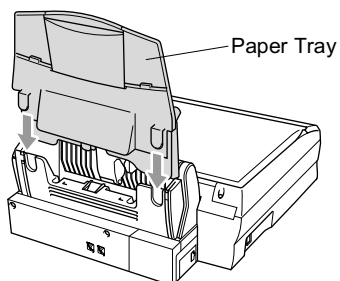

Paper is jammed inside the MFC.

- 1 Open the scanner cover by releasing the scanner cover release lever and lifting the scanner cover.

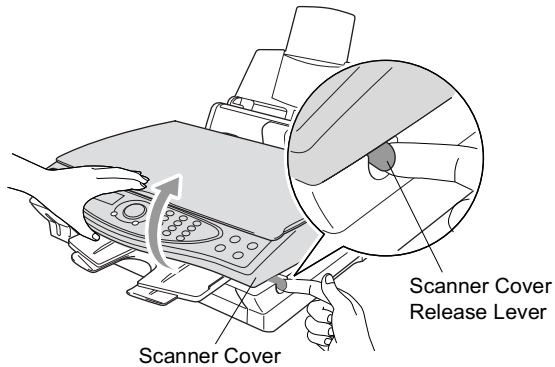

- 2 Remove the jammed paper.

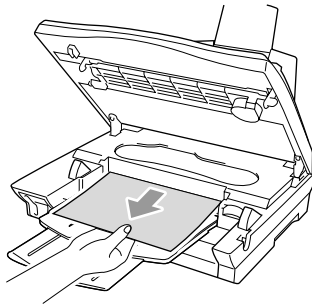

- 3 Close the scanner cover.



Do not touch the ink tube because it can cause damage to the machine itself.

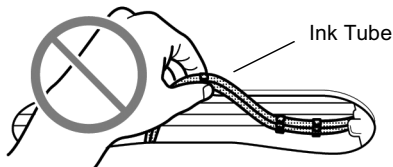

If you are having difficulty with your MFC

If you think there is a problem with the way your faxes look, *make a copy first*. If the copy looks good, the problem is probably not your MFC. Check the chart below and follow the troubleshooting tips.

DIFFICULTY	SUGGESTIONS
Printing or Receiving Faxes	
Condensed print and white streaks across the page or the top and bottom of sentences are cut off.	This can be caused by static or interference on the telephone line. You can make a copy using the Black Copy key to see if the same problem occurs. If the copy looks bad, call Brother Customer Service at 1-800-284-4329 (in USA), 1-877-BROTHER (in Canada) or (514) 685-6464 (in Montreal).
Poor quality print.	Make sure the Printer Driver or Paper Type setting in the menu matches the type of paper you are using. (See <i>Media Type</i> on page 13-3. See <i>Setting the Paper Type</i> on page 4-1.) If you are using plain paper, try using the types of recommended paper. (See <i>Paper</i> on page 2-1.) Don't handle the paper until the ink is dry. Adjust the Vertical Alignment. (See <i>Print Quality Check</i> on page 22-9.)
Smudged stain at the top center of the printed page.	Make sure the paper is not too thick. (See <i>Paper</i> on page 2-1.)
Printing is too dark or too light.	Make sure your ink cartridges are fresh. Cartridges are good for up to two years, after that the ink may become clogged. Cartridge expiration dates are printed on the package. Make sure the Printer Driver matches the type of paper you are using. (See <i>Media Type</i> on page 13-3.) Try using the recommended types of paper. (See <i>Paper</i> on page 2-1.) The recommended environment for your MFC is between 68°F to 91°F (20°C to 33°C).
Printing appears dirty or ink seems to run.	Make sure you are using the proper types of paper. (See <i>Paper</i> on page 2-1.) Don't handle the paper until the ink is dry. The recommended environment for your MFC is between 68°F to 91°F (20°C to 33°C).
White lines appear in text or graphics.	Clean the print heads. (See <i>Cleaning the print head</i> on page 22-9.)
Vertical black lines when receiving.	The sender's scanner may be dirty. Ask the sender to make a copy to see if the problem is on with the sending machine. Try receiving from another fax machine. If the problem continues, call Brother Customer Service at 1-800-284-4329 (in USA), 1-877-BROTHER (in Canada) or (514) 685-6464 (in Montreal).
Received color fax prints only in black and white.	Replace the color ink cartridges that are empty or nearly empty, and then ask the other person to send the color fax again. (See <i>Replacing the ink cartridges</i> on page 22-18.) Check that Fax Storage is set to OFF. (See <i>Setting Fax Storage</i> on page 8-1.)
Left and Right margins are cut off.	Turn on Auto Reduction. (See <i>Printing a reduced incoming fax (Auto Reduction)</i> on page 5-5.)

DIFFICULTY	SUGGESTIONS
Phone Line or Connections	
The MFC does not answer when called.	Make sure the MFC is in the correct receiving mode for your setup. (See <i>Basic receiving operations</i> on page 5-1.) Check for a dial tone. If possible, call your MFC to hear it answer. If there is still no answer, check the telephone line cord connection. If there is no ringing when you call your MFC, ask your telephone company to check the line.
Sending Faxes	
Poor sending quality.	Try changing your resolution to FINE or S. FINE . Make a copy to check your MFC's scanner operation.
Transmission Verification Report says 'Result:NG' or 'Result:ERROR'.	There is probably temporary noise or static on the line. Try sending the fax again. If you send a PC FAX message and get 'Result:NG' or, on the Transmission Verification Report, your MFC may be out of memory. To gain extra memory, you can turn off Fax Storage (See <i>Setting Fax Storage</i> on page 8-1), print fax messages in memory (See <i>Printing a fax from the memory</i> on page 5-7) or cancel a Delayed Fax or Polling Job (See <i>You can cancel a job while you are scanning it into memory by pressing Stop/Exit.</i> on page 6-10). If the problem continues, ask the telephone company to check your phone line.
Vertical black lines when sending.	If the copy you made shows the same problem, your scanner is dirty. (See <i>Cleaning the scanner</i> on page 22-17.)
Handling Incoming Calls	
MFC 'Hears' Voice as CNG Tone.	If your MFC is set to Easy Receive ON, it is more sensitive to sounds. Your MFC may mistakenly interpret certain voices or music on the line as a calling fax machine and respond with fax receiving tones. Deactivate the fax by pressing Stop/Exit . Try avoiding this problem by turning Easy Receive to OFF. (See <i>Easy Receive</i> on page 5-4.)
Sending a Fax Call to the MFC.	If you answered at the MFC, press Fax Start and hang up immediately. If you answered on an extension phone, press your Fax Receive Code (default setting is ✕ 51). When your MFC answers, hang up.
Custom features on a single line.	If you have Call Waiting, Call Waiting/Caller ID, Ring Master, Voice Mail, an alarm system or any other custom feature on a single phone line with your MFC, it may create a problem sending or receiving fax data. For example: If you are sending or receiving a fax message while a custom feature signal comes through on the line, the signal can temporarily interrupt or disrupt the fax data. Brother's ECM feature should help overcome this problem. This condition is related to the telephone system industry and is common to all devices that send and receive data on a single, shared line with custom features. If avoiding a slight interruption is crucial to your business, we recommend a separate phone line with no custom features.
Printer Difficulties	
Horizontal lines appear in text or graphics.	Clean the print head. (See <i>Cleaning the print head</i> on page 22-9.) If you clean the print heads five times and the print has not improved, call Brother Customer Service at 1-800-284-4329 (in USA), 1-877-BROTHER (in Canada) or (514) 685-6464 (in Montreal).
Scanning Difficulties	
TWAIN errors appear while scanning.	Make sure the Brother TWAIN driver is selected as the primary source. In PaperPort, click Scan in the File menu and select the Brother TWAIN driver.

DIFFICULTY	SUGGESTIONS
Software Difficulties	
Cannot perform '2 in 1 or 4 in 1' printing.	Check that the paper size setting in the application and in the printer driver are the same.
Cannot print when using Paint Brush.	Try setting the Display setting to '256 colors.'
Cannot print when using Adobe Illustrator.	Try to reduce the print resolution.
Thick lines and thin lines appear alternately. (banding)	1. Open the 'Basic' tab in the printer driver. 2. Click 'Setting' in the Basic tab of the printer driver. 3. Turn OFF 'Bi-Directional Printing' by un-checking it. (See <i>Bi-Directional Printing</i> on page 13-4.)
There are some dense lines.	Check 'Reverse Order' in the Basic tab of the printer driver.
Printing is slow.	In the 'Color' tab from the 'Advanced' tab in the printer driver, uncheck the Color Enhancement.
True2Life® is not working correctly.	If the image data is not full color in your application (Such as 256 color), True2Life® will not work. Please use at least 24 bit color data with the True2Life® feature.
'MFC is Busy' or 'MFC Connect Failure' Error Message appears.	Make sure the MFC is not showing an error message on the LCD.
'MFC Connect Failure'	If the MFC is not connected to your PC and you have loaded the Brother software, the PC will show 'MFC Connect Failure' each time you restart Windows®. You can ignore this message or you can turn it off by deselecting the AutoLoad PopUp check box in the Brother Control Center chapter. (See <i>How to turn off AutoLoad</i> on page 15-2.)
PhotoCapture Center™ Difficulties	
Removable Disk does not work properly.	<p>a) Have you installed the Windows® 2000 update? If not, do the following:</p> <ol style="list-style-type: none"> 1. Disconnect the USB cable. 2. Install the Windows 2000® update. Please see the Quick Setup Guide. After the installation the PC will be automatically restarted. 3. Wait about 1 minute after you reboot the PC, and then connect the USB cable. <p>b) Take out the media card and put it back in again.</p> <p>c) If you have tried "Eject", you must take out the media card before you continue.</p> <p>d) If an error message appears when you try to eject the media card, it means the card is being accessed. Wait a while and then try again.</p> <p>e) If all of the above do not work, please turn off your PC and MFC, and then turn them on again. (You will have to unplug the power cord of the MFC to turn it off.)</p>

How to improve print quality

Cleaning the print head

To ensure good print quality, the MFC will regularly clean the print head. You can start the cleaning process when needed.

Clean the print head and ink cartridges if you get a horizontal line in the text or graphics on your printed pages. You can clean two colors at a time (BLACK/CYAN or YELLOW/MAGENTA) or all four colors at once.

Cleaning the printhead consumes ink. Cleaning too often uses ink unnecessarily.

WARNING

Do NOT clean the print head by touching it with your hand or a cloth.

1 Press **Menu/Set, 5, 2.**

2 Press  to select the color you want to clean.

Press **Menu/Set.**

The MFC will clean the print head. When cleaning is finished, the MFC will go back online automatically.



If you clean the print head at least five times and the print has not improved, call Brother Customer Service for help at 1-800-284-4329 (in **USA**), 1-877-BROTHER (in **Canada**), or (514) 685-6464 (in **Montreal**).

Print Quality Check

If the print quality is not good, you can print a Print Quality Check Sheet to help you find the settings you may need to change.

1 Press **Menu/Set, 5, 1.**

MAINTENANCE
1. TEST PRINT

2 Press **Fax Start.**

The MFC begins printing the Print Quality Check Sheet.

TEST PRINT
PRESS FAX START

3 Check the sheet to see if the quality and alignment are OK by following STEPs A and B.

STEP A: Color block quality check

The LCD shows:

IS STEP "A" OK?
1. YES 2. NO

- 4 Check the quality of the four color blocks on the sheet.
(BLACK/CYAN/YELLOW/MAGENTA).
- 5 If all lines are clear and visible, press **1** (YES) to go to **STEP B**.
—OR—
If you can see missing short lines as shown below, press **2** (NO).

OK

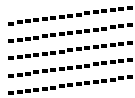

Poor



The LCD will ask you if the print quality is OK for each color.

BLACK OK?
1. YES 2. NO

- 6 Press **2** (NO) for any color with a problem.
The LCD shows:
Press **1** (YES). The MFC will start cleaning the colors.

START CLEANING?
1. YES 2. NO

- 7 After cleaning is finished, press **Fax Start**. The MFC will start printing the Print Quality Check Sheet again and then return to **STEP A**.
- 8 If **STEP A** is OK, press **1** to proceed to **STEP B**.

STEP B: Alignment Check

The LCD shows:

IS STEP "B" OK?
1.YES 2.NO

- 9** Check the 600 DPI and 1200 DPI test prints to see if number 5 most closely matches number 0. If the number 5 sample of both the 600 DPI and 1200 DPI are the best matches, press **1** (YES) to finish **STEP B**.

—OR—

If another test print number is a better match for either 600 DPI or 1200 DPI, press **2** (NO) to select it.

- 10** For 600 DPI, press the number of the test print that most closely matches the number 0 sample (1-8).

600DPI ADJUST
SELECT BEST #

- 11** For 1200 DPI, press the number of the test print that most closely matches the number 0 sample (1-8).

1200DPI ADJUST
SELECT BEST #

- 12** Repeat Steps 1 and 2 (in *Print Quality Check*) to print another sample Print Quality Check Sheet and then check it.

- 13** Press **Stop/Exit**.



When an ink head nozzle is clogged the printed sample looks like this.



After the ink head nozzle is cleaned, the horizontal lines are gone.

If you still see missing ink in this Print Quality Check Sheet, repeat the cleaning and test print procedures at least five times. If ink is still missing after the fifth cleaning and test print, replace the ink cartridge for the clogged color. (Perhaps the ink cartridge was in your MFC over six months or the expiration date written on the cartridge package has passed. Or, the ink may not have been stored properly before use.)

After replacing the ink cartridge, check it by printing another Print Quality Check Sheet. If the problem still exists, repeat the cleaning and test print procedures at least five times for the new ink cartridge. If ink is still missing, call Customer Service at 1-800-284-4329 (**in USA**), 1-877-BROTHER (**in Canada**) or (514) 685-6464 (**in Montreal**).

 **Caution**

Do NOT touch the print head. Touching the print heads may cause permanent damage and may void the print head's warranty.

Checking the ink volume

You can check the ink that is left in the cartridge.

- 1 Press **Menu/Set, 5, 3**.
- 2 Press  to select the color you want to check.
Press **Menu/Set**.
The LCD shows the ink volume.
- 3 Press **Stop/Exit**.

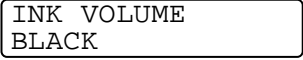

Packing and shipping the MFC

Whenever you transport the MFC, use the packaging that came with it. If you do not pack the MFC properly, you may void your warranty.

WARNING

Do NOT unplug the MFC after a print job until you hear the final click.

- 1 Pull the scanner cover release lever and lift the scanner cover.

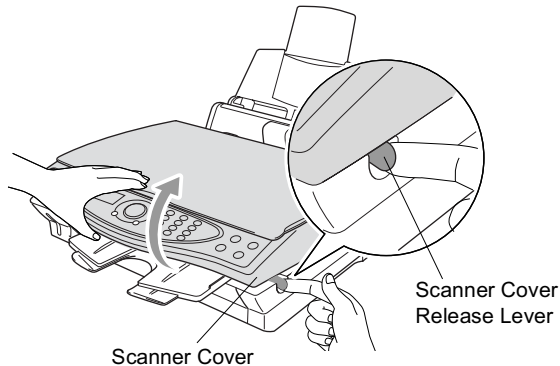

- 2 Remove all the ink cartridges and attach the protective cartridge covers. (See *Replacing the ink cartridges* on page 22-18.)
-  If you are not able to find the protective cartridges, do NOT remove the ink cartridges before shipping. It is essential that the MFC be shipped with either the shipping cover or the ink cartridges in position. Shipping without them will cause damage to your MFC and may void your warranty.

- 3 Remove the paper tray from the MFC.

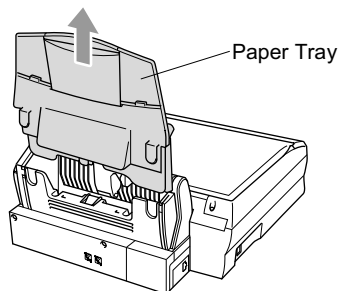

- 4 Unplug the MFC from the telephone wall jack (phone socket).
- 5 Unplug the MFC from the AC power outlet.
- 6 Unplug the USB cable from the MFC.
- 7 Remove the telephone line cord, and put all the parts in their original packaging or protective wrapping.
- 8 Wrap the MFC in the plastic bag.

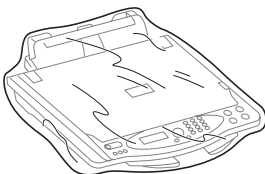

- 9** Place the MFC in the original box with the original packaging.

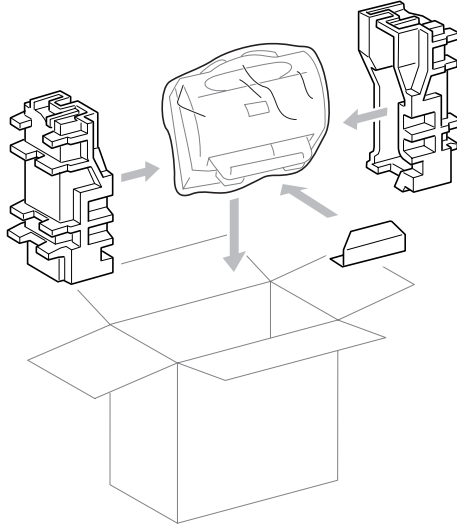

- 10** Pack the attachable parts and printed materials in the box. **DO NOT** pack the used ink cartridges.

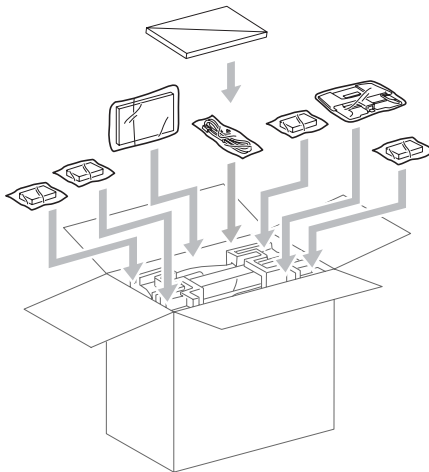

 If you are returning the MFC to Brother as part of the Brother Exchange Service, pack only the MFC. Keep all the attachable parts and printed materials to use with your 'Exchange' machine.

- 11** Close the box.

Routine maintenance

Cleaning the scanner

Lift the document cover. Clean the scanner glass and the white film with isopropyl alcohol on a soft lint-free cloth.

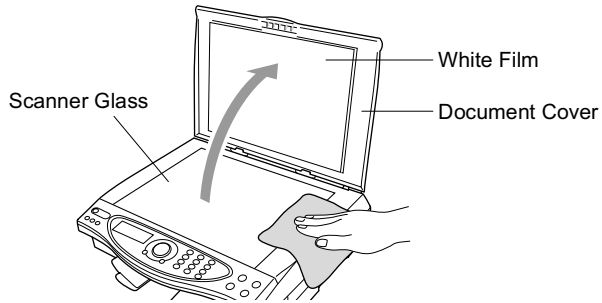

Replacing the ink cartridges

Your MFC is equipped with an ink dot counter that automatically monitors the ink level in each color cartridge. When the counter detects an ink cartridge is out of ink, the MFC will notify you with a message `INK EMPTY` on the LCD. The LCD shows you which color cartridges are empty. Be sure to follow the LCD prompts so you replace the color cartridges in the appropriate order.

- 1 Pull the scanner cover release lever and lift the scanner cover.
- 2 Lift the output paper support and open the ink cartridge cover.

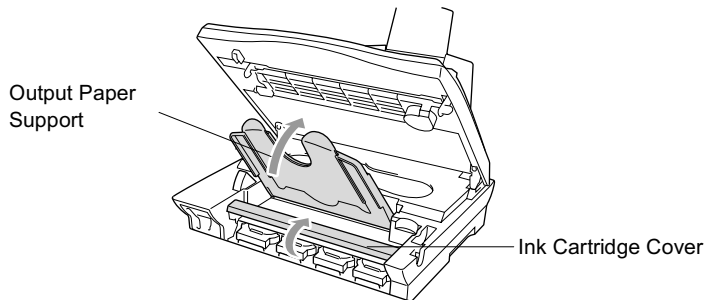

- 3 Remove the ink cartridges that are shown on the LCD.

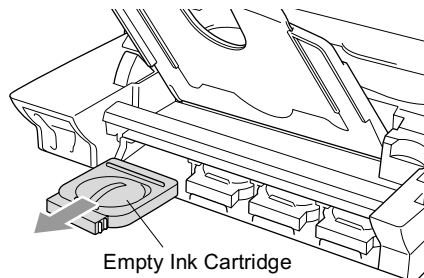

If one or more ink cartridges are empty, for example Black, the LCD shows `INK EMPTY BLACK` and `PLS OPEN COVER`.

- 4 Open the new ink cartridge bag for the color shown on the LCD, and then take out the ink cartridge.

- 5** Each color has its own correct position. Insert the new ink cartridge into its carriage by pressing until it clicks.

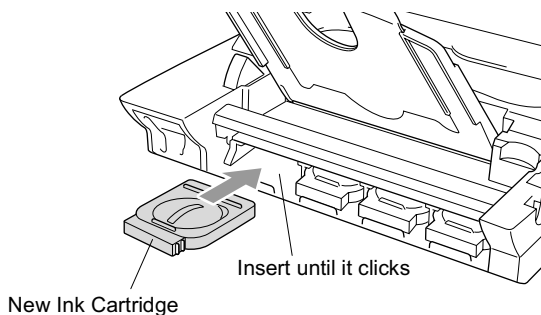

- 6** After installing the ink cartridges, close the ink cartridge cover, output paper support and scanner cover.
- 7** If you replaced an ink cartridge while **NEAR EMPTY XXXX** was displayed on the LCD, the LCD will ask you to verify that it was a brand new one. Example: **DID YOU CHANGE BLCK? 1.YES 2.NO**. For each *new* cartridge you installed, press **1** on the dial pad to automatically reset the ink dot counter for that color. If the ink cartridge you installed is not a brand new one, please be sure to select 2.



If you wait until **INK EMPTY XXXX** messages is displayed on the LCD, the MFC will automatically reset the ink dot counter.



If ink gets in your eyes, irrigate them with water immediately and call a doctor if you are concerned.

Caution

- DO NOT remove ink cartridges if you do not need to replace them. If you do so, it may reduce the ink quantity and the printer will not know the quantity of ink left in the cartridge.
- DO NOT shake the ink cartridges, because the ink may spill when you take off the sealing tape.
- If ink stains your body or clothing, wash with soap or detergent immediately.
- If you install an ink cartridge in the wrong color position, you must clean the print head several times before you start printing (after correcting the cartridge installation) because the colors were mixed.
- Once you open an ink cartridge, install it in the MFC and use it up within six months of installation. Use unopened ink cartridges by the expiration date written on the cartridge package.
- Brother strongly recommends that you do not refill the ink cartridges provided with your machine. We also strongly recommend that you continue to use only Genuine Brother Brand replacement ink cartridges. Using or attempting to use potentially incompatible inks and/or cartridges in your machine may cause damage to the machine itself and/or it may result in unsatisfactory print quality. Our warranty coverage does not apply to any problem that was caused by the use of unauthorized third party ink and/or cartridges. To protect your investment and guarantee your print quality please continue to replace consumed ink cartridges with only Genuine Brother Branded Supplies.



If the **INK EMPTY** message is on the display after you have installed ink cartridges, check that the ink cartridges are installed correctly.

If you still cannot solve a problem with your MFC, call Brother Customer Service. (See *Brother numbers* on page i.)

G Glossary

Auto Dial List A listing of names and numbers stored in Speed Dial memory, in numerical order.

Automatic fax transmission Sending a fax without picking up the handset of an external phone or pressing **Hook**.

Automatic Redial A feature that enables your MFC to redial the last fax number if the original fax did not go through because the line was busy.

Auto Reduction Reduces size of incoming faxes.

Batch Transmission As a cost savings feature, all delayed faxes to the same fax number will be sent as one transmission.

Backup Print Sets your MFC to print a copy of every fax that is received and stored in memory.

This is a safety feature so you will not lose message during a power failure.

Beeper The sound the keys make when they are pressed, an error occurs or a document has been received or transmitted.

Beeper volume Volume setting for the beep when you press a key or make an error.

Brightness Changing the Brightness makes the whole image lighter or darker.

Broadcasting The ability to send the same fax message to more than one location.

Cancel Job Cancels a programmed job, like Delayed Fax or Polling.

CNG tones The special tones (beeps) sent by fax machines during automatic transmission to tell the receiving machine that they are a from fax machine.

Communication error (or Comm. Error) An error during fax sending or receiving, usually caused by line noise or static.

Coding Method Method of coding the information contained in a document. All fax machines must use a minimum standard of Modified Huffman (MH). Your fax machine is capable of greater compression methods, Modified Read (MR), Modified Modified Read (MMR) and Joint Photographic Experts Group (JPEG), if the receiving machine has the same capability.

Compatibility Group The ability of one fax unit to communicate with another. Compatibility is assured between ITU-T Groups.

Contrast Setting to compensate for dark or light documents, by lightening dark documents or darkening light documents.

Delayed Fax Sends your fax at a later time that day.

Distinctive Ring A service purchased from the Telephone Company that provides another phone number on an existing phone line. The Brother MFC uses the new number to simulate a dedicated fax line.

Dual Access Your MFC can scan outgoing faxes or scheduled jobs into memory at the same time it is sending a fax or receiving or printing an incoming fax.

Easy Receive Enables your MFC to respond to CNG tones if you interrupt a fax call by answering it.

ECM (Error Correction Mode) Detects errors during fax transmission and resends the pages of the document that had an error.

Extension phone A telephone on the fax number that is plugged into a separate wall jack.

External phone A TAD (telephone answering device) or telephone that is plugged into the EXT jack of your MFC.

F/T Ring Time The length of time that the Brother machine rings (when the receive mode setting is FAX/TEL) to notify you to pick up a voice call that it answered.

Fax Activity Report Lists information about the last 200 incoming and outgoing faxes. TX means Transmit. RX means Receive.

Fax Forwarding Sends a fax received in memory to another preprogrammed fax number.

Fax Receive Code Press this code (✖ **51**) when you answer a fax call from an extension or external phone.

Fax Storage You can print stored faxes later, or retrieve them from another location using Fax Forwarding, Paging, or Remote Retrieval functions.

FAX/TEL You can receive faxes and telephone calls. Do not use this mode if you are using a telephone answering device (TAD).

Fax tones The signals sent by sending and receiving fax machines while communicating information.

Fine resolution Resolution is 196 × 203 dpi. It is used for small print and graphs.

Gray scale The shades of gray available for copying and faxing photographs.

Group number A combination of Speed Dial numbers that are stored as a Speed Dial number for Broadcasting.

Help list A printout of the complete Menu that you can use to program your machine when you do not have the User's Guide with you.

Interval The preprogrammed time period between automatically printed Activity Reports. You can print Activity Reports on demand without interrupting this cycle.

LCD (liquid crystal display) The display screen on the MFC that shows interactive messages during On-Screen Programming and shows the date and time when the machine is idle.

Manual fax When you lift the handset of your external telephone or press **Hook** so you can hear the receiving fax machine answer before you press Start to begin transmission.

Menu mode Programming mode for changing your machine's settings.

Multi-Function Link Pro[®] Suite Turns your MFC into a printer and a scanner and enables PC faxing using the MFC.

Near Edge Allows you to reduce unprintable areas.

Next Fax Reservation Dual Access accepts the next original on the scanner glass for transmission while the Memory is full.

OCR (optical character recognition) The bundled ScanSoft® TextBridge® software application converts an image of text to text you can edit.

Out of Paper Reception Receives faxes into the MFC's memory when the machine is out of paper.

Overseas Mode Makes temporary changes to the fax tones to accommodate noise and static on overseas phone lines.

Paging Feature enables your fax unit to call your pager when a fax is received into its memory.

Pause Allows you to place a 3.5 second delay in the dialing sequence stored on Speed Dial numbers.

PhotoCapture Center™ Allows you to print digital photos from your digital camera at high resolution for photo quality printing.

Photo resolution A resolution setting that uses varying shades of gray for the best representation of photographs.

Polling The process of a fax machine calling another fax machine to retrieve waiting fax messages.

Printer alarm Audible alarm when the printer is not able to print.

Pulse A form of rotary dialing on a telephone line.

Real Time Transmission When memory is full, you can send documents in real time.

Remaining jobs You can check which jobs are waiting in memory and cancel jobs individually.

Remote Activation Allows you to transfer a fax call, answered at an external or extension phone, to the MFC.

Remote Retrieval Access The ability to access your MFC remotely from a touch tone phone.

Remote Access Code Your own four-digit code (---*) that allows you to call and access your MFC from a remote location.

Resolution The number of vertical and horizontal lines per inch. See: Standard, Super Fine and Photo.

Ring Delay The number of rings before the MFC answers in FAX mode.

Ring Volume Volume setting for the MFC's ring.

Scanning The process of sending an electronic image of an original paper document into your computer.

Scan to Card You can scan a black and white or color original into a Media Card. Black and white images will be in TIFF file format and color images may be in PDF or JPEG file format.

Search An electronic, alphabetical listing of stored Speed Dial and Group numbers.

Speed Dial A preprogrammed number for easy dialing. You must press the **Search/Speed Dial** key and then **#**, two digit code to start the dialing process.

Standard resolution 97 x 203 dpi. It is used for regular size text and quickest transmission.

Station ID The stored information that appears on the top of faxed pages. It includes the sender's name and fax number.

Super fine resolution 392 x 203 dpi. Best for very small print and line art.

TAD (telephone answering device) You can connect an external TAD to the EXT. jack of the MFC.

Telephone Answer Code (FAX/TEL mode only) When the machine answers a voice call, it pseudo/double-rings. You can pick up at an extension phone by pressing this code (**# 5 1**).

Temporary Settings You can select certain options for each fax transmission without changing the default settings.

Tone A form of dialing on the telephone line used for Touch Tone telephones.

Transmission The process of sending documents over the phone lines from your MFC to the receiving fax machine.

Transmission Verification Report A listing of each transmission, that shows its date, time and number.

True2Life® Adjusts the color in the image for better print quality by improving sharpness, white balance and color density.

User Settings A printed report that shows the current settings of your MFC.



Specifications

Product description

The MFC-4420C is a **6in1** Multi-Function Center: Color Printer, Color Copier, Color Scanner, Plain Paper Color Fax, PhotoCapture Center™ and PC Fax Sending (via your PC).

General

Memory Capacity	16 MB
Paper Tray	Up to 100 Sheets (20 lb)
Printer Type	Ink Jet
Print Method	Piezo with 75 x 4 nozzles
LCD (Liquid Crystal Display)	16 characters x 2 Lines
Operating Environment	50-95 °F (10-35 °C)
Best Print Quality	68-91 °F (20-33 °C)
Power Source	120V AC 50/60Hz (USA and Canadian Version Only)
Power Consumption	Minimum: under 5.8 watts ** Standby: under 9.2 watts Operating: under 21 watts

Dimensions

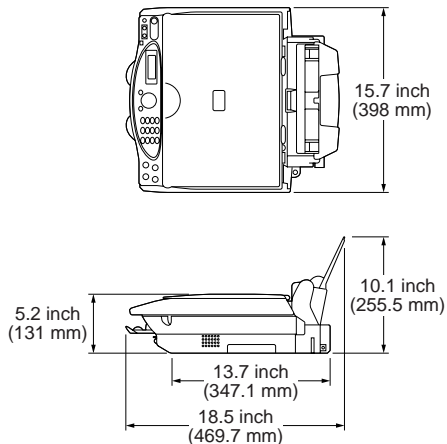

Weight	17.6 lb / 8 kg (with components)
---------------	-------------------------------------

** When Power Switch (On/Off) is turned off.

Print media

Paper Input

Paper Tray

- Paper type:
Plain paper, inkjet paper (coated paper), glossy paper, transparencies and envelopes
- Paper size:
Letter, Legal, A5, Executive, envelopes (commercial No. 10, DL, C5), Post card, Index card.
Width: 3.2-8.5" (89-216 mm)
Height: 5.0-14" (127-356 mm)
For more details, see Paper Specifications for Paper Tray on page 2-2.
- Maximum paper tray capacity: Approx. 100 sheets of 20 lb (80 g/m²) plain paper.

Paper Output

Up to 30 sheets of plain paper (Face up print delivery to the output paper support)
To prevent smearing the ink, we recommend removing printed pages from the output paper support immediately after they exit the MFC.

Copy

Color/Mono

Color/Mono:

Copy Speed

Mono
Up to 10 pages/minute (Letter paper)*
Color
Up to 6 pages/minute (Letter paper)*
* Does not include the time it takes to feed the paper.

Enlarge/Reduce

25% to 400% (in increments of 1%)

Resolution

Print: Max. 1200 x 1200 dpi
Scan: Max. 600 x 600 dpi

Photo Capture Center

Available Media

CompactFlash®
(Microdrive™ is not compatible)
(Compact I/O card such as Compact LAN card and Compact Modem card are not available.)
SmartMedia®(3.3V)
(Not available for use with ID)
Memory Stick®.
(Not available for music data with MagicGate)

File Extension

JPEG (Progressive JPEG format is not available)

Number of Files

Up to 999 files in the media card

Folder

File must be in the 3rd stratum of the folder of Media Card

Fax

Compatibility	ITU-T Group 3
Coding System	Mono: MH/MR/MMR Color: JPEG
Modem Speed	14400 bps Automatic Fallback
Original Size	Scanner Width: Max. 8.5" (216 mm) Scanner Height: Max. 11.7" (297 mm)
Scanning Width	8.2 inches (208 mm)
Printing Width	8.03 inches (204 mm)
Gray Scale	Mono: 64 Color: 256 levels (Error Diffusion)
Polling Types	Standard, Sequential: B&W only
Contrast Control	Automatic/Super Light/Super Dark (manual setting)
Resolution	<ul style="list-style-type: none">• Horizontal 203 dot/inch (8 dot/mm)• Vertical Standard - 98 line/inch (Black) (3.85 line/mm) 196 line/inch (Color) (7.7 line/mm) Fine - 196 line/inch (Black/Color) (7.7 line/mm) Photo - 196 line/inch (Black) (7.7 line/mm) Superfine - 392 line/inch (Black) (15.4 line/mm)
Speed Dial	80 stations
Broadcasting	Up to 130 locations; Up to 6 Groups
Automatic Redial	one time after 5 minutes
Auto Answer	0, 1, 2, 3 or 4 rings
Speaker Type	Monitor
Communication Source	Public switched telephone network
Memory Transmission	Up to 480 pages *
Out of Paper Reception	Up to 480 pages *

* "Pages" refers to the "Brother Standard Chart No. 1" (a typical business letter, Standard resolution, MMR code). Specifications and printed materials are subject to change without prior notice.

Scanner

Color/Mono	Color/Mono
TWAIN Compliant	Yes
Resolution	Up to 9,600 × 9,600 dpi (interpolated) Up to 600 × 2,400 dpi (optical)
Scanning Speed	Color: up to 11 sec. Mono: up to 3 sec. * Letter size in 100 × 100 dpi
Document Size	Scanner Width: Max. 8.5" (216 mm) Scanner Height: Max. 11.7" (297 mm)
Scanning Width	8.2 inches (208 mm)
Gray Scale	256 levels

Printer

Printer Driver	Windows® 98/98SE/Me/2000 Professional and XP driver supporting Brother Native Compression mode and bi-directional capability Apple® Macintosh® QuickDraw® Driver For OS 8.6-9.2/OS X 10.1/10.2.1 or greater
Resolution	2400 x 1200 dots per inch (DPI) 1200 x 1200 dots per inch (DPI) 600 x 600 dots per inch (DPI) 600 x 300 dots per inch (DPI) 600 x 150 dots per inch (DPI)
Print Speed	up to 13 pages/minute (Grayscale) up to 11 pages/minute (Color)
Printing Width	8.03 inches (204 mm)
Near Edge	approximately 0.02 in. margins (A4/LTR/4x6 Post card/5x8 Index card) (Not available for transparencies)
Disk-Based Fonts	35 TrueType

Specifications and printed materials are subject to change without prior notice.

Interface

USB	A Standard Universal Serial Bus cable that is not longer than 6 feet (1.8m). (USB cable not included)
------------	---

Computer Requirements

Minimum System Requirements						
Computer Platform & Operating System Version		Processor Minimum Speed	Minimum RAM	Recommended RAM	Available Hard Disk Space	
					Drivers + ScanSoft® SW	ArcSoft® SW
Windows® Operating System	98, 98SE	Pentium 75MHz	24 MB	32 MB	150 MB	150 MB
	Me	Pentium 150MHz	32 MB	64 MB		
	2000 Professional	Pentium 133MHz	64 MB	128 MB	280 MB	
	XP	Pentium 233MHz				
Apple® Macintosh® Operating System	OS 8.6 - 9.2 (Printing, Scanning and PC-FAX sending only)	All base models meet minimum Requirements	32 MB	64 MB	50 MB	200 MB
	OS X 10.1 (Printing and Remote Setup only)					
	OS X 10.2.1 or greater (Printing, Scanning, PC-FAX sending and Remote Setup only)		128 MB	160 MB		

NOTE: All registered trademarks referenced herein are the property of their respective companies.

For the latest drivers, access the Brother Solutions Center at <http://solutions.brother.com>

Consumable Items

Ink

Black and 3 individual color ink cartridges separate from the print heads.

Service Life of Ink Cartridge

Approximately 480 page/Black cartridge at 5% coverage with 600 x 150 dpi resolution (Fast).

Approximately 400 page/Color cartridge at 5% coverage with 600 x 150 dpi resolution (Fast).



These numbers are based on consecutive printing; the numbers will vary based on print frequency and number of pages.

The MFC periodically cleans the print head to maintain print quality. This process consumes a small amount of ink.

Index

The items in the upper case represent LCD messages.

A

- access codes, storing and dialing 7-4
- accessories and supplies ii
- automatic
 - dialing 7-4
 - fax receive 5-1
 - fax redial 6-7

B

- Broadcasting 6-11
 - setting up Groups for 7-3
- Brother
 - accessories and supplies ii
 - Brother numbers i
 - Customer Service i
 - fax back system ii
 - Frequently Asked Questions (FAQs) i
 - product support i
 - test sheet, sending 1-2
 - Warranties iii, iv, vi
- Brother Control Center
 - using and configuring 15-1

C

- CALL PICKUP 5-12
- Caller ID 5-12, 5-13
- canceling
 - a scheduled fax job 6-10
 - fax forwarding 8-6
 - paging 8-6
 - while scanning a fax 6-10
- cleaning
 - print head 22-9
 - scanner 22-17

- CNG tones 1-10
- computer requirements S-5
- connecting
 - external TAD 1-12
 - external telephone 1-11
- consumable items S-5
- control panel, overview 1-6
- copy
 - brightness 10-9
 - color adjustment 10-14
 - contrast 10-13
 - default settings 10-12
 - enlarging 10-7
 - keys 10-4
 - multiple 10-2
 - paper 10-8
 - quality 10-6, 10-13
 - reducing 10-7
 - scanner glass 10-2
 - single 10-2
 - specifications S-2
 - temporary settings 10-4
- Credit Card Numbers 7-4
- custom telephone features 1-18, 22-7

D

- Date and Time 4-2
- Delayed Batch Transmission 6-15
- Delayed Fax 6-14
- dialing
 - a pause 7-5
 - access codes and credit card numbers 7-4
 - automatic fax redial 6-7

Groups 6-11
 Distinctive Ring 5-9
 drivers
 Macintosh 20-1
 printer 13-1
 TWAIN Compliant 14-1
 Dual Access 6-8

E

Easy Receive 5-4
 ECM (Error Correction Mode)
 1-11
 entering text 4-4
 envelopes 2-2, 2-4
 error messages on LCD 22-1
 BLCK 1. YES 2. NO 22-19
 CHECK PAPER 22-1
 COMM. ERROR 22-1
 DID YOU CHANGE 22-19
 INK EMPTY 22-2
 MEMORY FULL 22-2
 NOT REGISTERED 22-2
 OUT OF MEMORY
 while scanning
 a document 6-8, 10-3
 extension telephone, using ... 5-6
 external telephone 1-11

F

fax codes
 Fax Receive Code 5-6
 Remote Access Code 8-4
 Telephone Answer Code ... 5-6
 Fax Forwarding 8-2
 changing remotely 8-6, 8-7
 programming a number ... 8-2
 Fax Receive Code 5-6, 5-7
 Fax Storage 8-1
 Backup Print 8-1
 Fax Forwarding/Paging 8-2

 printing from memory 5-7
 turning on 8-1
 fax, stand-alone
 receiving 5-1
 at end of conversation ... 5-5
 difficulty 22-6
 erasing from the memory
 8-6
 forwarding 8-2, 8-6
 polling 1-17, 5-8
 reducing to fit on paper ... 5-5
 retrieving from a remote
 site 8-7
 ring delay, setting 5-2
 sending
 at end of conversation 6-4
 color fax 6-7
 contrast 6-5
 delayed 6-14
 from memory
 (Dual Access) 6-7, 6-8
 manual transmission 6-3
 multiple settings 6-5
 overseas 6-13
 polling 6-16
 Real Time Transmission ... 6-9
 redialing 7-5
 resolution 6-6
 specifications S-3
 FAX/TEL mode 5-1
 answering at extension
 phones 5-6
 double-ringing (voice calls)
 5-3
 Easy Receive 5-4
 FAX Receive Code 5-7
 receiving faxes 5-6
 Setting F/T Ring Time 5-3
 Setting Ring Delay 5-2
 Telephone Answer Code ... 5-6

FCC notices 21-1

G

gray scale S-3, S-4

Groups for Broadcasting 7-3

H

HELP 3-1, 9-3

I

ink cartridges

 checking ink volume 22-13

 replacing 22-18

interface specifications S-4

J

jacks

 convert to RJ11 jack 1-15

 EXT. jack

 external telephone 1-11

 TAD (answering

 machine) 1-12

 triple adapter 1-15

L

LCD (Liquid Crystal

 Display) 1-6, 3-1

 contrast 4-8

M

Macintosh® G3, G4 or iMac™
or iBook™ 20-1

maintenance, routine 22-17

manual

 receive 5-1

 transmission 6-3

Memory Storage 3-1

Menu mode 3-1

multi-line connections

 (PBX) 1-18

N

Near Edge

 Print 13-6

O

Options key (copying)

 Brightness 10-9

 Paper Size 10-9

 Paper Type 10-8

OUT OF AREA 5-12

P

Paging 8-2, 8-3

 programming your pager

 number 8-2

Paper 2-1, S-2

 capacity 2-2

 Size 4-2

 Type 4-1

PaperPort®

 accessing 14-2

 exporting 14-24

 importing 14-23

 uninstall 14-24

PC FAX (For Windows®) ... 18-1

 sending

 address book 18-6

 cover page 18-12

 facsimile style 18-14

 group 18-8

 setting up 18-12

 simple style 18-15

phone line

 connections 1-14

 difficulties 22-7

 multi-line (PBX) 1-18

 roll-over lines 1-15

 two-line phone system 1-15

PhotoCapture Center™

 Compact Flash® 11-1

DPOF printing 11-14
 Memory Stick® 11-1
 Printing images 11-6
 Printing Index 11-5
 SmartMedia® 11-1
 specifications S-2
 Polling
 receiving 5-8
 sending 6-16
 sequential receiving 5-8
 power
 failure 3-1
 print
 area 2-4
 difficulty 22-6
 fax from memory 5-7
 Improving quality 22-9
 jams 22-3
 media S-2
 resolution S-4
 specifications S-4

Q

Quality key
 (copying) 10-4, 10-6

R

Receive mode
 EXTERNAL TAD 5-1
 FAX ONLY 5-1
 FAX/TEL 5-1
 MANUAL 5-1
 Redial/Pause 6-7
 reducing
 copies 10-7
 long faxes 5-5
 Remote Retrieval 8-5
 access code 8-4, 8-5
 changing the code 8-4
 commands 8-6

getting your faxes 8-7
 Reports 9-1
 Transmission Verification ... 9-1
 resolution
 fax (Standard, Fine,
 SuperFine, Photo) S-3
 print S-4
 Scan 14-6
 setting for next fax 6-6
 Ring Delay, setting 5-2

S

Safety Instructions vii, 21-5
 scanner
 specifications S-4
 Scanning into PC 14-3
 ScanSoft® PaperPort® ... 14-20
 Scansoft® TextBridge®
 OCR 14-23
 Setup
 Date and Time 4-2
 Station ID (fax header) 4-3
 software
 Brother Control Center ... 15-1
 ScanSoft® Paper Port® ... 14-20
 Speed Dial 1-6
 changing 7-2
 storing 7-1

T

TAD (Telephone Answering
 Device), external
 1-12, 1-17, 5-1
 connecting 1-11
 receive mode 5-1
 Temporary Copy Settings ... 10-4
 text, entering 4-4
 Special Characters 4-5
 Tone Signals on
 Pulse Line 7-5

- troubleshooting 22-1
 - error messages
 - on LCD 22-1
 - if you are having difficulty
 - incoming Calls 22-7
 - phone line difficulty 22-7
 - printer difficulties 22-7
 - printing or receiving
 - faxes 22-6
 - sending faxes 22-7
- True2Life®
 - PhotoCapture Center™ .. 11-17
 - Print 13-11
- two-line phone system 1-15

V

- Volume, setting 4-6
 - beeper 4-6
 - ring 4-6
 - speaker 4-7

W

- Warranties iii
 - Canada vi
 - Notice-Disclaimer iii
 - USA iv
- World Wide Web i

Remote Retrieval Access Card

If you plan to receive fax messages while away from your MFC, carrying the Remote Retrieval Access Card printed below will serve as a convenient reminder of the retrieval procedures. Simply cut out the card and fold it to fit your wallet or organizer. Keeping it handy will help you derive the full benefit of your MFC's Forwarding, Paging and Remote Retrieval features.

REMOTE RETRIEVAL ACCESS CARD

Using Remote Access Code

- 1 Dial your fax number from a telephone or fax machine using touch tone.
- 2 When your MFC answers, immediately enter your Remote Access Code (3 digits followed by *).
- 3 Your MFC signals the kinds of messages received:
1 long beep — Fax messages
No beeps — No messages.
- 4 After 2 short beeps, enter a command.
- 5 Press **90** to reset your MFC when you finish.
- 6 Hang up.

CHECK RECEIVING STATUS
Press **971**
1 long beep — Fax messages
3 short beeps — No messages

CHANGE RECEIVE MODE
Press **98**
then for **EXTERNAL TAD**, press 1.
FAX/TEL, press 2.
FAX ONLY, press 3.

EXIT REMOTE OPERATION
Press **90**.

Fold → ← Fold

1 1

Changing Remote Access Code

"When you are at the machine:"

- 1 Press **Menu/Set**, 2, 5, 3.
- 2 Enter a three-digit number from 000 to 999. The * cannot be changed.
- 3 Press **Menu/Set**.
- 4 Press **Stop/Exit**.

Remote Commands

CHANGE PAGING/FAX FORWARDING SETTING

- Press **9 5**.
- then to* Turn feature **OFF**, press **1**.
Select **Fax Forwarding**, press **2**.
Select **Paging**, press **3**.

Fold

Program Fax Forwarding Number, press **4**. Enter the new fax number where you want your fax messages forwarded followed by **##**.

- Turn **Fax Storage ON**, press **6**.
- Turn **Fax Storage OFF**, press **7**.

RETRIEVE A FAX

- Press **9 6**.
- then to* Retrieve all faxes, press **2**, then enter the number of remote fax machine, followed by **##**.
After the beep, hang up and wait.
Erase all fax messages, press **3**.

Fold

EQUIPMENT ATTACHMENT LIMITATIONS (Canada only)

NOTICE

This product meets the applicable Industry Canada technical specifications.

NOTICE

The Ringer Equivalence Number is an indication of the maximum number of devices allowed to be connected to a telephone interface. The termination on an interface may consist of any combination of devices subject only to the requirement that the sum of the RENs of all the devices does not exceed five.

brother®

Brother International Corporation
100 Somerset Corporate Boulevard
P.O. Box 6911
Bridgewater, NJ 08807-0911 USA

Brother International Corporation (Canada) Ltd.
1 rue Hôtel de Ville,
Dollard-des-Ormeaux, QC, CANADA H9B 3H6

**Visit us on the World Wide Web
<http://www.brother.com>**

These machines are made for use in the USA and CANADA only. We cannot recommend using them overseas because it may violate the Telecommunications Regulations of that country and the power requirements of your multi-function center may not be compatible with the power available in foreign countries. **Using USA or CANADA models overseas is at your own risk and may void your warranty.**